

**SL-A370 PRIMROSE 3D  
MASSAGE CHAIR**  
OPERATION INSTRUCTIONS

**SAVE THESE INSTRUCTIONS**

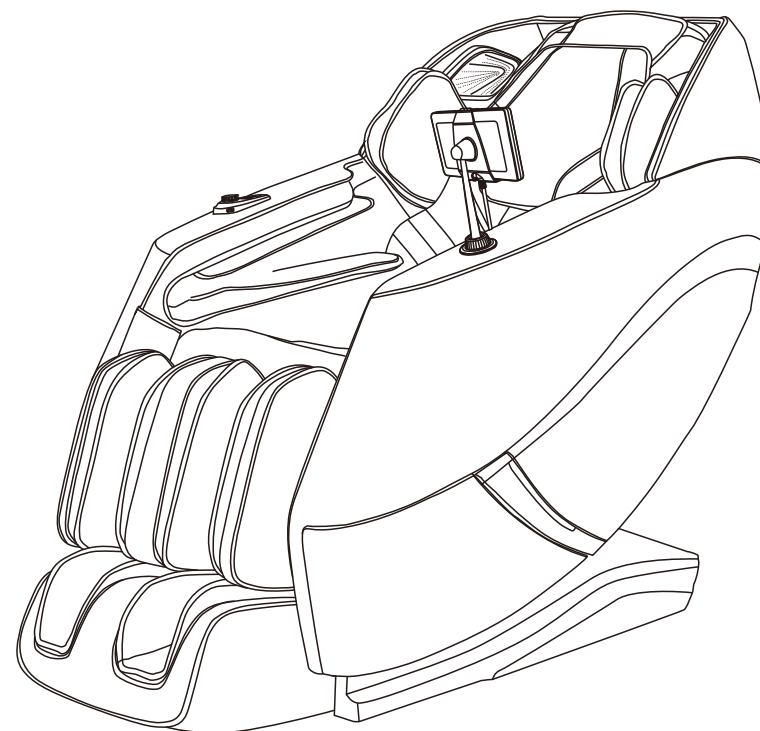

Thanks for purchasing this product. Please read this manual instruction carefully in order to know how to use this product correctly before operation. Please pay more attention to some important safety warning and keep this manual book properly for future use.

Note: Our company reserves the right to change and explain the design of the product. If there is some difference between the product function in market circulation and the description in the manual, it is a normal update of the product, and our company will not inform you otherwise. The specific product function and color shall prevail in kind.

**CONTENTS**

**Before Use**

---

Safety Precautions ----- 02-04  
Installation Parts ----- 05  
Place Massage Chair ----- 06-07  
Before Use ----- 08-09  
Product Structure ----- 10-15

**Usage Method**

---

Operation Instructions ----- 16-22

**Maintain**

---

Cleaning and Maintenance ----- 23



**Important**

---

Troubleshooting ----- 24  
Product Specifications ----- 25

**Safety Precautions** (must be observed)

- Please read all relevant instructions carefully before use.
- The notes marked here will help you to use the product safely and correctly.
- In order to clearly indicate the extent of harm and damage, precautions are divided into **"Warning"** and **"Caution"** that may be caused by incorrect use. Both of them are important for safety and must be followed.

 <b>Warning</b>	Indicates that serious injury or death may result from improper use.
 <b>Caution</b>	Indicates that misuse may cause minor injury or property damage.

- Please pay attention to the symbol before each safety item.

 <b>Forbidden</b>	Absolute prohibition
--	----------------------

**The following populations should not use this product**

 <b>Forbidden</b>	<ul style="list-style-type: none"> <li>■ The device is not intended for use by persons (including children) with physical disabilities, sensory or neurological impairments or who lack experience and common sense, unless they are supervised and instructed in the use of the device by those responsible for their safety. Children must be supervised to ensure they do not play with instruments.</li> <li>■ Patients with osteoporosis.</li> <li>■ Patients with heart disease or wearing electronic medical devices such as a pacemaker.</li> <li>■ People who have a fever.</li> <li>■ Pregnant women or women on their menstrual period.</li> <li>■ Patients who are injured or have a skin disease.</li> <li>■ When unsupervised, any children are under the age of 14 and those unconscious are not allowed to use this product.</li> <li>■ People who are told by their physicians to have rest or who feel unwell.</li> <li>■ People whose bodies are wet are forbidden to use this product.</li> <li>■ This product has a hot surface. Persons insensitive to heat must pay attention when using this product.</li> <li>■ If the supply cord is damaged, to avoid danger, it must be replaced by a professional from the manufacturer, its maintenance department or similar department</li> </ul>
---	---

**Safety Precautions** (must be observed)

<b>Important safety warnings</b>	
 <b>Warnings</b>	<ul style="list-style-type: none"> <li>■ Do not allow children to touch any movable part of this product.</li> <li>■ Use the well-grounded power supply unit suitable for this product.</li> <li>■ Pull out the plug after use or before cleaning to avoid any physical injury or damage to the product.</li> <li>■ Operate this product as instructed in this manual.</li> <li>■ Do not use any parts or accessories which are not recommended.</li> <li>■ Do not use this product outdoors.</li> <li>■ Please read the Operation Instructions carefully before operation.</li> <li>■ Never use this product for any other purpose not listed herein.</li> <li>■ 20 minutes of usage each time is recommended.</li> <li>■ Do not use this product if the cover or leather is broken or damaged.</li> <li>■ Do not drop anything into this product.</li> <li>■ Never fall asleep while using this product.</li> <li>■ Do not use this product if you are drunk or feel unwell.</li> <li>■ Do not use this product within one hour after a meal.</li> <li>■ Do not use this product with excessive force to avoid any injury.</li> </ul>

<b>Safety precautions</b>	
 <b>Caution</b>	<ul style="list-style-type: none"> <li>■ Check whether voltage is consistent with the specification of this product.</li> <li>■ Never insert or pull out the plug with a wet hand.</li> <li>■ Do not let water flow into this product to avoid electric shock or cause damage to this product.</li> <li>■ Do not pull the power cord when plugging or unplugging it. Rough handling is forbidden.</li> <li>■ Do not damage the wire or modify the circuit of this product.</li> <li>■ Do not clean live parts of this product with a wet cloth such as a power switch and plug.</li> <li>■ Be away from this product in case of power failure to avoid any injury if power is restored suddenly.</li> <li>■ Stop using this product at once while it works abnormal, and consult your local supplier.</li> <li>■ Stop using this product if you feel unwell, and consult your health care practitioner.</li> </ul>

<b>Storage conditions</b>	
 <b>Caution</b>	<ul style="list-style-type: none"> <li>■ Storage room temperature: 5 °C to 40 °C.</li> <li>■ Relative humidity (RH) between 20% and 80%; free of corrosive gases, and a well-ventilated room.</li> </ul>

## Safety Precautions must be observed

<b>Product service and maintenance</b>	
 <b>Caution</b>	<ul style="list-style-type: none"><li>■ This product should be maintained by the service center designated by the manufacturer only. No user should disassemble or maintain it without permission.</li><li>■ Do not forget to turn off the main power switch after usage.</li><li>■ Do not use this product if the power socket becomes loose.</li><li>■ If this product will be left unused for a long period of time, it is necessary to roll up the power cord of this product and store this product in a dry and dust-free environment.</li><li>■ Do not store this product at a high temperature or near open flame. Avoid prolonged exposure to direct sunshine.</li><li>■ Please clean this product with dry cloth. Never use thinner, benzene or alcohol.</li><li>■ The mechanical components of this product are specially designed and manufactured, so no special maintenance is needed.</li><li>■ Do not use a sharp object to stab at this product.</li><li>■ Do not roll or pull this product on any uneven ground. Instead, it should be lifted before moving.</li><li>■ Please use this product intermittently. Do not keep it working continuously for a long period of time.</li></ul>

<b>Operating environment</b>	
 <b>Caution</b>	<ul style="list-style-type: none"><li>■ Do not use this product in a very moist environment such as the bathroom.</li><li>■ Stop using this product immediately when the ambient temperature changes sharply.</li><li>■ Do not use this product in any heavily-dusty or caustic environment.</li><li>■ Do not use this product in a small space or a place without good ventilation.</li></ul>

<b>Solutions to ordinary malfunctions</b>	
 <b>Caution</b>	<ul style="list-style-type: none"><li>■ If the motor sounds during operation of this product, this is the normal operation sound.</li><li>■ If the controller cannot work normally, check whether the plug and the power socket are connected reliably, and whether the power switch is turned on.</li><li>■ If the rated working time is over, this product will automatically activate the power-off button; If this product keeps operating for a long period of time, the temperature protector will stop this product automatically. The product can be used again after half an hour.</li></ul>

## Installation parts

### Calf installation instructions

1. Insert the wire of the calf and the air pipe into the front socket of the steel frame assembly (Figure 1).
2. Then push the connected wire and air pipe into the hole in the backrest frame (Figure 2).
3. After the wire docking is completed, open the calf fixing covers on both sides of the steel frame assembly (Figure 3).
4. Lift the calf into the notch, close the fixing covers, and secure it in place with 2 pieces screws (Figure 4).

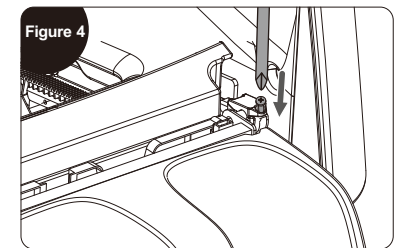
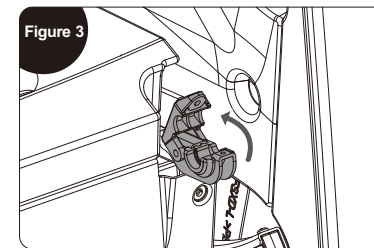
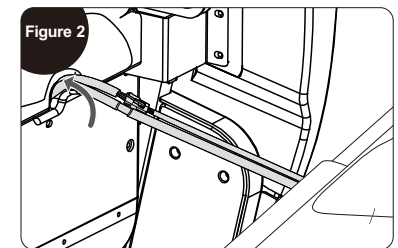
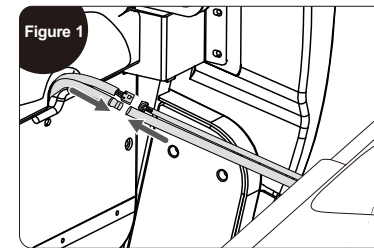

## Place massage chair

### Installation placement

**Make sure there is enough space for the massage chair can be tilted at least 15 cm.**

Do not expose the massage chair directly to high temperature environment due to sunlight (such as: in front of heating equipment), and place it to where can avoid high temperature and direct sunlight. It is recommended to lay a soft cushion for long-term use in a designated location. When laying the cushion, the size of the cushion should be enough to cover the range where the machine touches the floor and the range where your feet touch the floor.

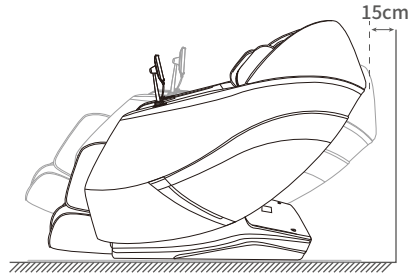

### Product lift instruction

**Require team work to lift and move the chair to avoid injury.**

1. Please lift the massage chair to move it on vulnerable ground such as wooden floor.  
2. When moving on a similar wooden floor, it is recommended to lift it. Avoid damage to the casters. When the floor is lifted and moved to the designated position, be careful to keep your hands out of the way to avoid injury, and be careful of your feet being crushed. Do not let go of the unit until the unit is completely flat, the floor may be damaged, therefore, it is recommended to place mats, etc. on the floor.

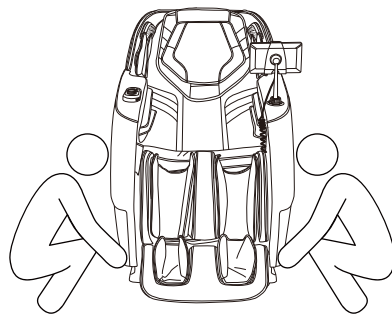

## Place massage chair

### Move method

**Use the rear casters to move the massage chair. Move the chair by tilting it down and backward about 45° as shown in the diagram.**

**NOTE: Excessive force to title will cause the chair to tip over completely and product damage.**

1. Before moving, please shut down the machine properly to reset the whole machine, and then cut off the power.
2. Please keep the chair vacant when moving. (People, pets or clutter will not be able to stay on the chair.)
3. When moving, do not cross a drop barrier higher than 2mm or a gap greater than 5mm.
4. When using casters to move this product, single continuous movement is not supported; if the distance exceeds 50 meters, please make this product move slowly and evenly.

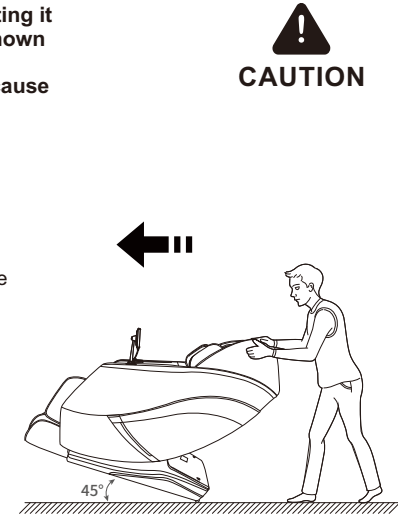

### How to disassemble and use headrest cushion and backrest cushion

Using a headrest cushion can reduce the intensity of kneading massage on the neck and shoulders, and you can decide whether to use a headrest cushion according to your needs (recommended to use a headrest cushion). The backrest cushion and the backrest are connected by a zipper (1), and the headrest cushion and the backrest cushion are connected by a zipper (2).

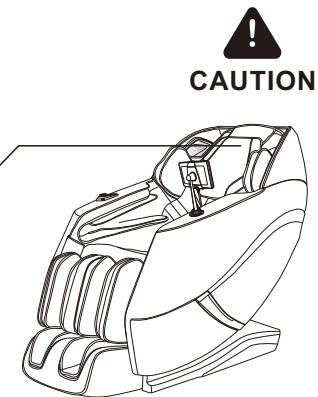
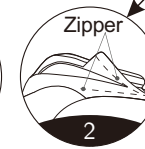
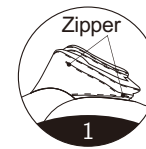

## Before use

### Check around

Make sure that there are no people, pets and other objects around the unit.

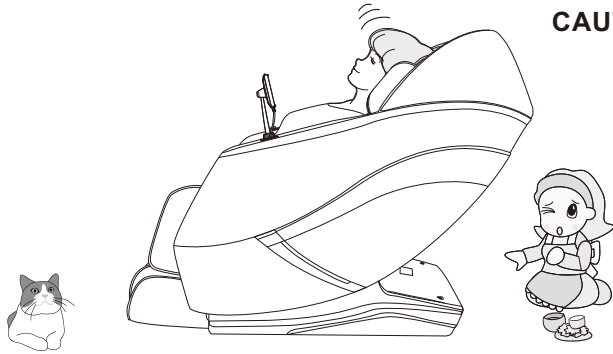

### Make sure there are no foreign objects in the gaps of the machine

Before massaging, make sure that no foreign objects are caught in the legs, feet, etc.  
Under no circumstances allow hands, feet, and head to penetrate into the area between the lower leg mechanism and main body, or the area between the armrest and the capsule.  
Under no circumstances should hands, feet, or head sink under the fabric or leather covering of the massage area.

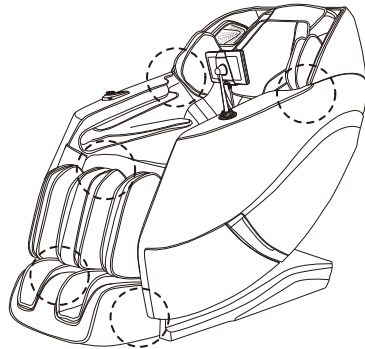

## Before Use

### Turn on the power

#### **Caution**

Plug in power cord

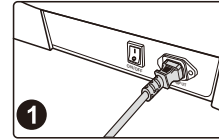

Schematic diagram of power on

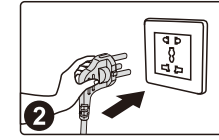

Turn on the power switch ("I" position)

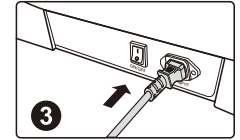

- Please check whether the power cord and power plug are damaged before use.
- Please supply power to this product in accordance with the working power requirements of this product's calibration.
- It is strictly forbidden to use a power supply other than the nominal power supply of this product.
- It is strictly forbidden to connect various power conversion devices to supply power to this product without authorization.

## Product Structure

### Parts description

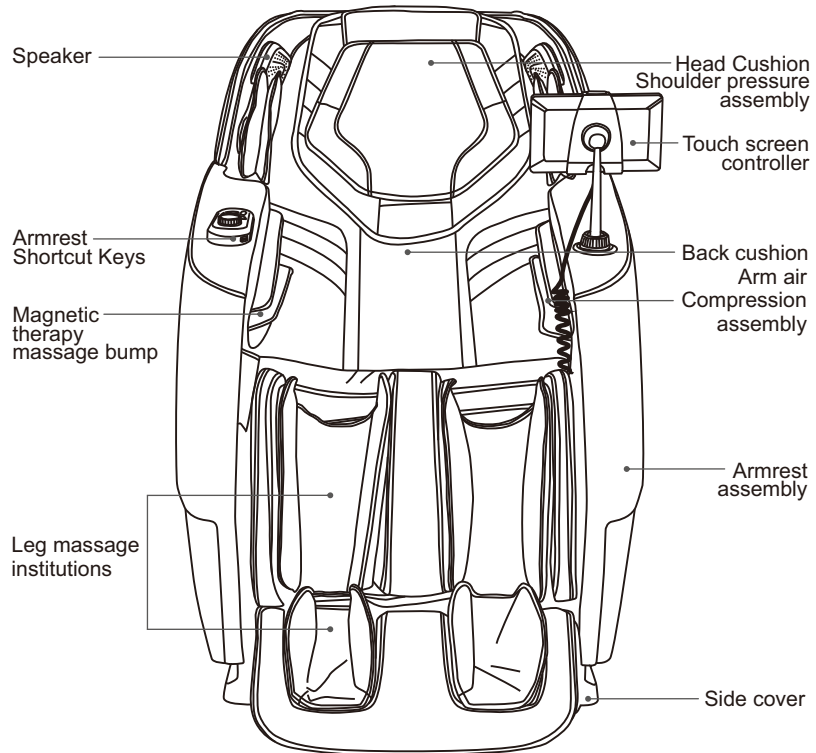

## Product Structure

### Function distribution

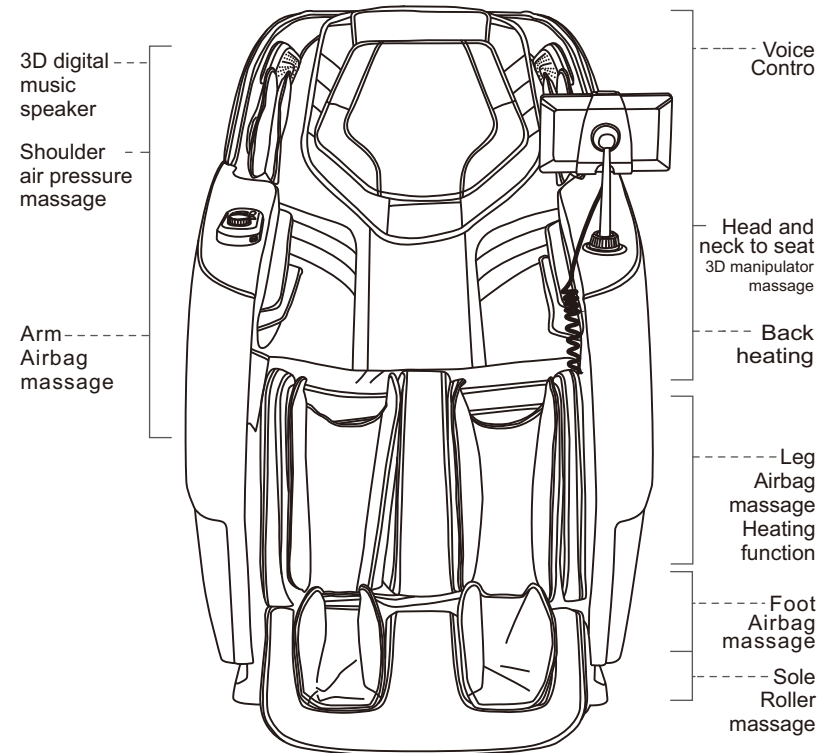

## Product Structure

### I .Introduction of the remote controller

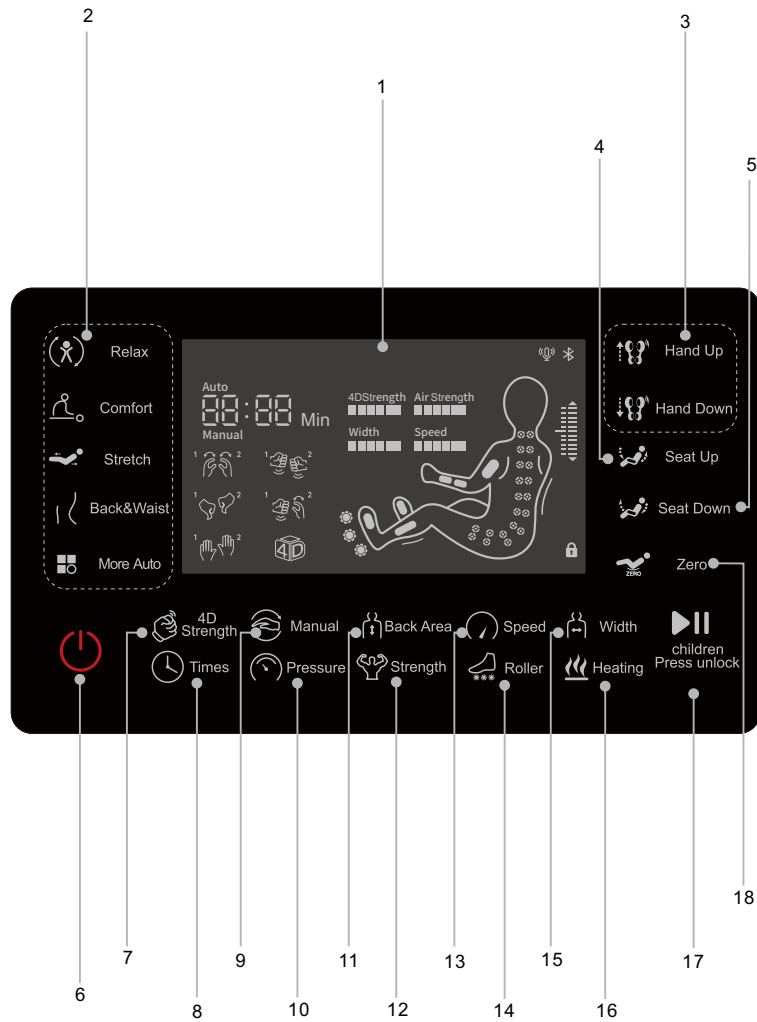

## Product Structure

- 1.LCD screen  
-Display all massage functions.
- 2.Auto Key  
-For details,please refer to page 17 of this manual.
- 3.Massage hand adjust key  
-Adjust the position of shiatsu points on shoulder,massage positions adjustment ( in fixed point mode and partial mode , the massage position can be adjusted ).
- 4.Sitting posture up button  
-Adjust the sitting posture to rise.
- 5.Sitting posture down button  
-Adjust the sitting posture to descend.
- 6.Power switch key  
-Turn on or off all massage chair functions.
- 7.4D strength  
-Adjust back strength, 5 levels adjustable.
- 8.Times Key  
-Time adjustment please refer to page 20 of this manual for detail instructions.
- 9.Manual key  
-For details,please refer to page 18 of this manual .
- 10.Air pressure area key  
-Adjust the massage area,for detailed instructions,please refer to page 19 of this manual.
- 11.Massage area key  
-Adjust the massage area,for detailed instructions,please refer to page 18 of this manual.
- 12.Air pressure intensity key  
-A total of five levels of air pressure can be adjusted.
- 13.Speed key  
- There are 5 levels of massage speed that can be adjusted.
- 14.Foot roller key  
-For details,please refer to page 19 of this manual.
- 15.Width key  
-A total of three levels of width can be adjusted.
- 16.Back heating key  
-Turn on/ Off heating.
- 17.Pause/start key  
- For details,please refer to page 19 of this manual.
- 18.Auto lying key  
-There are three automatic lying modes and reset and standing modes, which can be switched cyclically according to your own needs.  
-Turn voice control on or off.

## Product Structure

### II. Introduction to Armrest Shortcut Keys

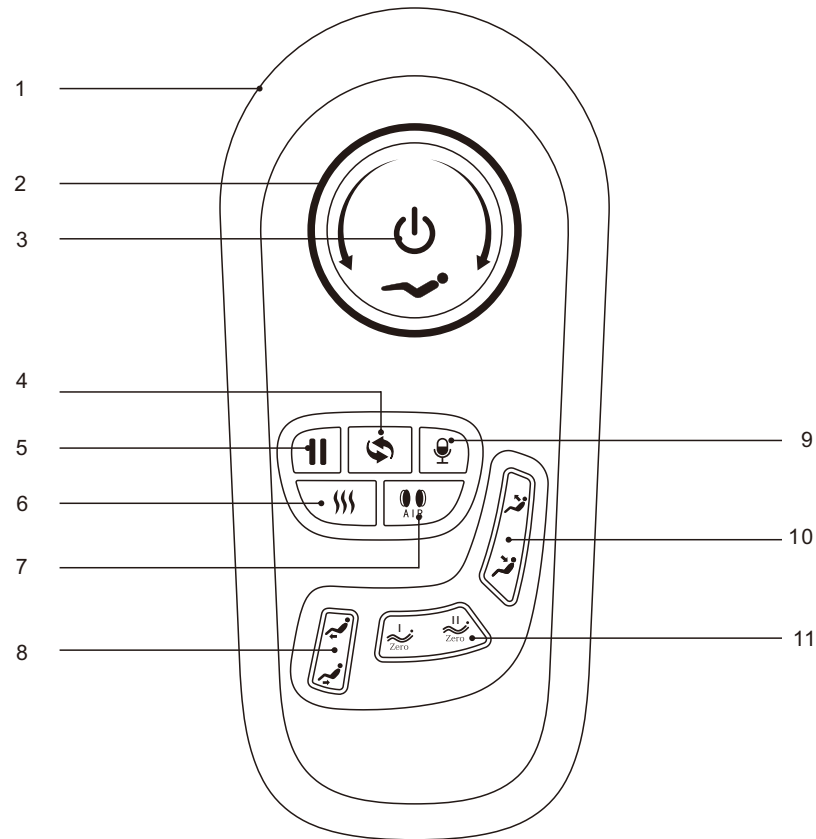

- 1.USB charging jack: or intelligent device charging.
- 2.Adjust key: adjust the up or down of the backrest frame and the calf frame interactively.
- 3.On/Off key: turn the massage chair on/off.
- 4.Auto key: switch from/to the automatic massage function.
- 5.Pause key: suspend all massage functions.
- 6.Heat key: turn the heat function on/off.
- 7.Air: turn the pneumatic massage function on / off.
- 8.Calf frame Up and Down key: adjust the up or down of calf frame.
- 9.Voice control key: Turn ON/OFF the voice control function.
- 10.Backrest frame Up and Down key: adjust the up or down of the backrest frame.
- 11.Zero Gravity key: adjust massage chair to the zero gravity angle.

## Product Structure

Function	Description
	USB jack: USB charging port, you can charge smart devices (such as mobile phones).Open key: short press this key to open key.
	Power key: Short press this key to turn ON/OFF the massage.
	Linkage lying knob: By rotating this knob clockwise, the backrest will move downward slowly and the legrest will rise slowly; by releasing it, such DOWN/UP action of the backrest and the legrest will be stopped.
	Linkage sitting knob: By rotating this knob counterclockwise, the backrest will rise slowly and the legrest will move downward slowly; by releasing it, such UP/DOWN action of the backrest and the legrest will be stopped.
	Press this key during massage, and all the massage actions will be suspended at once. (i.e. the massage chair will turn off after 20min). Then press this key again to restore all the previous massage actions.
	Auto mode key: each time the key is short pressed, it will be switched to next automatic massage function.
	Voice wake up button: short press this button to wake up the voice control function. Long press 3 seconds to open/close voice control function.
	Heat treatment key: Click the key to enable or disable the heat treatment function.
	Air pressure key: press this button to switch the air pressure mode
	Legrest up key: Pull the button to make the legrest rise slowly. Release it to stop such action.
	Legrest down key: Press the button to make the legrest move downward slowly. Release it to stop such action.
	Zero-gravity key I : the positions of the legrest and the backrest can be automatically adjusted to the positions I for zero gravity.
	Zero-gravity key II : the positions of the legrest and the backrest can be automatically adjusted to the positions II for zero gravity.
	Backrest up key: the back rest keeping lifting when pressing this key, and black rest stopped lifting once release the key.
	Backrest down key: the back rest keeping reclining when pressing this key, and black rest stopped reclining once release the key.

## Operation Instructions

### III. Start massage

- ①. Press the power button to start the massage, the default is relax massage.
- ②. Automatic angle adjustment (you can press the "More Auto"/"↺" button to skip).
- ③. Automatic human shoulder position detection, keep the sitting posture fit with the massage chair (you can press the "More Auto" / "↺" button to skip).
- ④. Shoulder position fine-tuning, if the detected position deviates from the actual shoulder position, adjust it to the appropriate position through the up and down buttons of the shoulder position (you can press the "More Auto"/ "↺" button to skip), there are 11 shoulder positions in total. If there is no adjustment within 10 seconds, it will enter into the massage function.

Note: You can select the automatic function during the booting process. Repeatedly selecting the same automatic function can skip the booting process and enter the massage directly.

Button	Description	Display
↑↺ Hand Up	Move the massage balls upward to a suitable position	↑↑↑↑
↓↺ Hand Down	Move the massage balls downward to a suitable position	↓↓↓↓

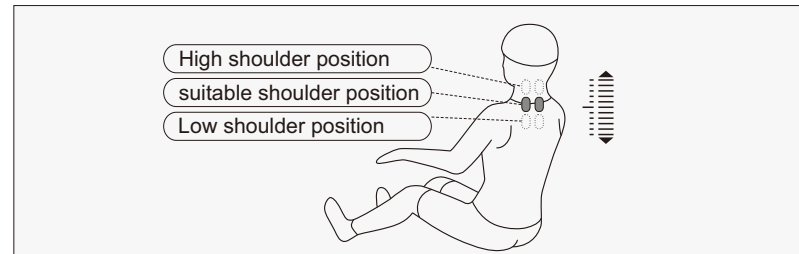

In the process of detecting shoulder position and massage position, press up or down keys to adjust the shoulder position when there's beep sound.

## Operation Instructions



















### • Automatic massage

Function	Button	Description	Display	
Automatic massage	⊗ Relax	Relax: the depth of the soft and comfortable massage, relieve body fatigue.	Auto 01	
	⌚ Comfort	Comfort: The most comfortable massage experience.	Auto 02	
	↔ Stretch	Frame and backrest frame rise and fall, and air pressure massage, and stretch or traction on the leg, remove fatigue, restore vitality.	Auto 03	
	{ Back & Waist	Back&waist: focus on back and waist massage.	Auto 04	
	More Auto		Shoulder & neck: focus on shoulder and neck massage.	Auto 05
			Full body massage: deep massage to rejuvenate the body.	Auto 06
			Spinal massage: Focus on spine massage and fully relieve the fatigue and pain from your body.	Auto 07
			Ache relieve: Deep massage on the acupressure points can effectively relieve ache.	Auto 08
			Bottom Toing: Improve overall blood circulation of body to enhance vitality and immunity .	Auto 09
			Beautiful buttocks shaping: effective massage for the buttocks and thighs , plays a role in shaping the body, reducing the accumulation of excess body fat.	Auto 10
			Good-night sleep : massage the twelve health acupoints to help the body regulate balance, quickly improve sleep and improve sleep quality.	Auto 11
			Leisure Heath: for sedentary sitting in the office, massage can increase the amount of physical activity and improve the body's function.	Auto 12
			Sport Recovery: quickly recover from physical fatigue after exercise.	Auto 13
			Superior Enjoyable: an effective massage on the shoulders and neck, can help to nourish the body and adjust various indicators of the body.	Auto 14
		Body Balance: release stress, relieve fatigue, balance body and mind, help sleep.	Auto 15	

Note: Automatic programs 1, 2, and 3 include background music. Press and hold "Relax massage" for 3 seconds to turn on/off the background music.



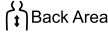
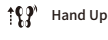



## Operation Instructions

### • Manual massage



Function	Button	Description	Display
Technique		Knead: speed.	
		Tap: speed, width.	
		Knead Knock: speed.	
		Shiatsu: speed, width.	
		Knock: speed, width.	
		4D Knead:Speed.	
		4D Tap:Speed, Width.	
		4D Knead Knock:Speed.	
4D Shiatsu: width.			
Speed		Adjustable 5 gears in speed.	
Width		The width of the third gear can be adjusted.	
4D Strength		5 levels of strength can be adjusted.	
Back stretch		Fixed position and spot massage.	H1 Manual
		Small area local round trip massage.	H2 Manual
		A round trip massage.	H3 Manual
		Upper Back: A round-trip massage on the upperback.	H4 Manual
		Lower Back: A round-trip massage for the lowerback.	H5 Manual
		Hand Up	Massage position adjustment (in fixed point and local mode, massage position can be adjusted).
	Hand Down		Manipulator descending

## Operation Instructions



### • Pneumatic massage

Function	Button	Description	Display
Air pressure Mode		Full pressure: air pressure massage on arms, legs and feet.	
		Arm: air pressure massage with the arm as the focus.	
		Leg: barometric massage for leg, foot.	
intensity		Five levels can be adjusted.	





### • Foot roller massage

Function	Button	Description	Display
Foot roller		Press this button to turn on or off the foot roller massage, and has a weak, medium, strong three levels of intensity can be adjusted to close the four states of cycle switching.	

### • Heated massage



Function	Button	Description	Display
Heat		Press this button to turn on or turn off the far-infrared hyperthermia of the back and calf, and it will warm after 3 minutes.	

### • Pauselstart massage button

Function	Button	Description	Display
Pause/start		Press this button in the process of massage, and all massage movements will be suspended urgently when time continues to countdown), and then press this key to resume all before suspension massage.	
V-chip		Press and hold Pause/start key for 3 seconds, display shows  that lock is successful, and other keys cannot be used after being locked; press and hold Pause/start for 3 seconds in locked state, and the display disappears  , indicating that unlock is successful and keys function returns to normal.	

## Operation Instructions

### ·Adjust lying Angle

Function	Button	Description
Sit up	 Seat Up	Press this button, backrest frame slowly rise, calf frame slowly fall, and issued "di...di..."until it reached the top. Press this button again in the process of sitting, then stop sitting immediately.
Lay down key	 Seat Down	Press this key, backrest frame slowly down, calf frame slowly up, and issued "di...di..."until it stops. Press this key again in lying down process, stop lying down immediately.
Lie down automatically	 Zero	Each time the button is pressed, it switches to an automatic lying mode, with a total of four modes (including the reset and standing mode), which can be switched cyclically.Press and hold for 3 seconds to turn the voice control function on or off.

### ·Other manual functions

Function	Button	Description	Display
Timing	 Times	Time adjustment, every time to press will add 5 minutes, can not exceed 30 minutes, if more than 30 minutes return to the minimum time value.	20min

### IV.Operation Instructions for Bluetooth Speaker Play

- 1.The smart device will search for the corresponding Bluetooth model(e.g. IMCM-XXXX), Click he "Match" button, if you are asked whether to match with the device, you just select "Match" to complete matching.
- 2.Turn on "Music Player" in the smart device and select the song to play.

### V. Voice Control Mode

- When the massage chair is turned on or in standby mode the sound "Hi Alice"or "Hey Alice"will be produced to enable the voice control function. Alternatively, you can press the voice control button on the armrest to enable the voice control function.
- After such function is enabled successfully, the massage chair will reply "I am here" At this moment, once a corresponding voice control entry to be implemented is given within six seconds, the corresponding voice control entry to be implemented is given within six seconds, the corresponding voice control function can be performed after a reply is received from the massage chair if no correct voice control entry is given within six seconds, the voice control function automatically will be off automatically and needs to be enabled again.

## Operation Instructions

- Note: When using the voice control function, the speech speed should not be too fast, and the voice commands should be issued according to the voice control entries. After each successful use of the voice-activated entry, it is recommended to give out the voice command after 1-2 seconds.

Voice Control Entry		
Entry: "Hi Alice" or "Hey Alice". Answer: I am here.		
No.	Voice control entry	Answer entry
1	Massage on	Answer: Ok, massage on
2	Massage close	Answer: Ok, massage close
3	Comfort Massage	Answer: Ok, comfort massage
4	Relax massage	Answer: Ok, relax massage
5	Full body massage	Answer: Ok, full body massage
6	Neck and shoulder massage	Answer: Ok, neck and shoulder massage
7	Back and waist massage	Answer: Ok, back and waist massage
8	Stretch massage	Answer: Ok, stretch massage
9	Open the air pressure	Answer: Ok, open the air pressure
10	Close the air pressure	Answer: Ok, close the air pressure
11	Up the seat position	Answer: Ok, up the seat position
12	Down the seat position	Answer: Ok, down the seat position
13	Change the other mode	Answer: Ok, change the other mode
14	Go little down	Answer: Ok, go little down
15	Go little up	Answer: Ok, go little up
16	Fixed massage	Answer: Ok, Fixed massage
17	Stop adjustment	Answer: Ok, Stop adjustment

## Operation Instructions

### VI. End the massage

1. During the massage process, press the power key off touch screen controller to immediately turn off all massage functions, the backrest and leg rest will reset, or when the massage timer expires, it will automatically turn off all massage functions, but the backrest and leg rest will not reset.

Cut off the power of the whole machine. Figure (switch power off)

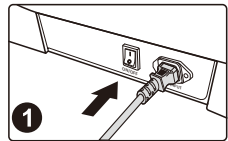

Power off ("0" position)

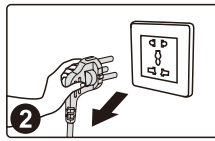

Take off the power plug

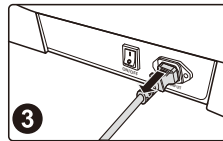

Take off the product power cable.

## Cleaning and Maintenance

### Clean PU leather and plastic parts

Wipe the leather with a soft, dry cloth.

- Do not use chemicals such as thinner, gasoline, alcohol, etc. to clean the unit.
- When using commercially available leather care products (rags), please follow the instructions for use.

■ If the PU leather is particularly dirty, wipe it by the following methods.

- ① Immerse a soft cloth in water or hot water containing 3% to 5% neutral detergent, then wring it out thoroughly.
- ② Use the above soft cloth to wipe the leather surface.
- ③ Wipe off the cleaning solution with a cloth soaked in clean water and thoroughly wrung out.
- ④ Wipe with a wrung soft cloth.
- ⑤ Let it air dry naturally.

■ When it is difficult to remove stains, please immerse commercially available melamine foam in neutral detergent, and then wipe the machine with it.

■ Do not use a hair dryer to dry the surface.

■ As the color of the fabric will stain the surface of the PU leather, be careful when wiping the chair with denim and colored fabrics.

■ Do not keep these parts in contact with plastic for a long time, as this will cause discoloration.

■ PU leather may be discolored, so when using hair dye, please cover the touched part with a towel.



## Troubleshooting

<b>Fault</b>	When the calf mechanism or the backrest reaches a certain position, press the corresponding adjustment button and it will no longer change, and a continuous "beep, beep" sound will be emitted.
<b>Solution</b>	Due to product structure design and ergonomic requirements, this product has a limited protection design for the limit state of attitude adjustment. At the same time, a reminder sound will sound when the limit is reached.
<b>Fault</b>	The function does not work or some functions do not work after the machine is turned on.
<b>Solution</b>	After the machine is turned on by pressing the switch key, it is necessary to manually select an automatic massage program or other working state. If it is not operated, the machine will automatically shut down after 20 minutes. If the manual operation mode is selected, the functions that are not selected may be disabled, and the working mode needs to be manually set in the manual mode.
<b>Fault</b>	The machine makes a leather rubbing sound when adjusting its posture.
<b>Solution</b>	This product adopts high-grade anti-corrosion leather that meets environmental protection requirements. Due to the inherent characteristics of leather materials, there will be a normal slight noise when rubbing at the relative movement, which is a normal phenomenon. Note: If you hear fabric or leather tearing sound when the machine is running, please stop using it immediately and seek professional maintenance.
<b>Fault</b>	The massage wheel did not reach the shoulders or neck.
<b>Solution</b>	If the head does not touch the head cushion or the back does not touch the backrest, the shoulder position may be lower than the actual position during the body shape detection process. Sit in the deepest position of the seat, rest your head on the headrest, and start over from the beginning.
<b>Fault</b>	The unit is damaged. The power cord or power plug is abnormally hot.
<b>Solution</b>	To prevent accidents, be sure to contact an authorized service center.

Please feel free to contact the designated service personnel for any questions or doubts about this product.

## Product Specifications

Model: SL-A370 PRIMROSE 3D

Name: Massage Chair

Rated voltage: 110-120V~ 60Hz   
220-240V~ 50Hz/60Hz

Rated power:100W

Rated time: 20min

Safety structure: Class I

Material description: PVC, PA, steel parts, electric and electron components

MATERIAL	PU	LEATHER	CLOTH	WOOD