

A229-2 MASSAGE CHAIR

OPERATION INSTRUCTIONS

SAVE THESE INSTRUCTIONS

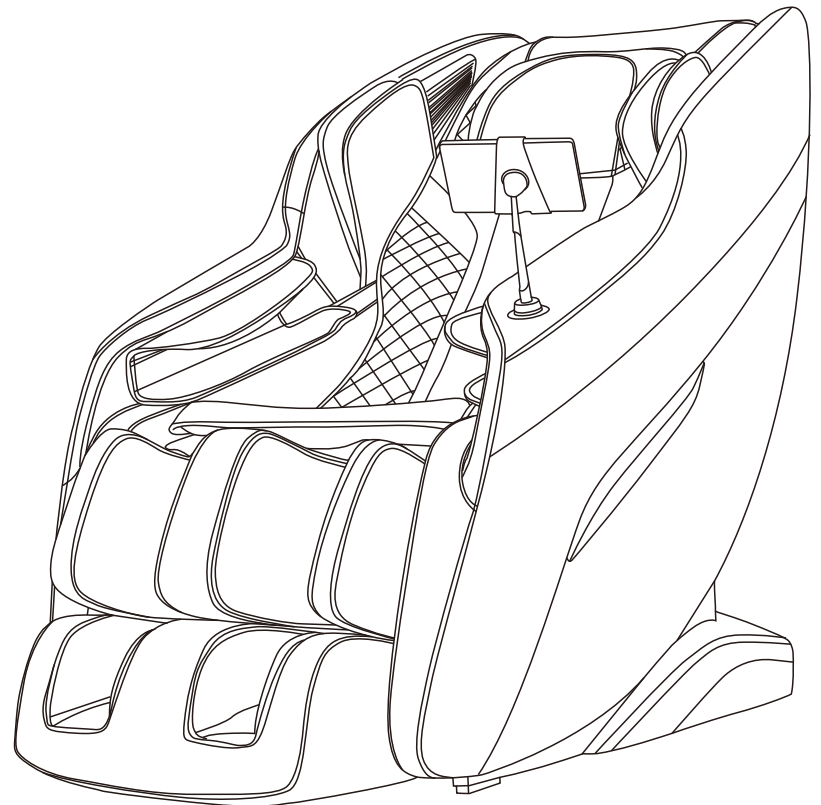

Thanks for purchasing this product. Please read this manual instruction carefully in order to know how to use this product correctly before operation. Please pay more attention to some important safety warning and keep this manual book properly for future use.

Note: Our company reserves the right to change and explain the design of the product. If there is some difference between the product function in market circulation and the description in the manual, it is a normal update of the product, and our company will not inform you otherwise. The specific product function and color shall prevail in kind.

TABLE OF CONTENTS

Before use

Safety Precautions	02-04
Installation parts	05
Place massage chair	06-07
Before use	08-09
Product structure	10-13

Usage method

Operation Instructions	14-20
Massage close	20

Maintain



Cleaning and Maintenance	21
--------------------------	----

Important

Troubleshooting	22
Product Specifications	23

Safety Precautions must be observed

- Please read all relevant instructions carefully before use.
- The notes marked here will help you to use the product safely and correctly.
- In order to clearly indicate the extent of harm and damage, precautions are divided into **"Warning"** and **"Caution"** that may be caused by incorrect use. Both of them are important for safety and must be followed.

 Warning	Indicates that serious injury or death may result from improper use.
 Caution	Indicates that misuse may cause minor injury or property damage.

- Please pay attention to the symbol before each safety item.

 Forbidden	Absolute prohibition
--	----------------------

The following populations should not use this product

 Forbidden	<ul style="list-style-type: none"> ■ The device is not intended for use by persons (including children) with physical disabilities, sensory or neurological impairments or who lack experience and common sense, unless they are supervised and instructed in the use of the device by those responsible for their safety. Children must be supervised to ensure they do not play with instruments. ■ Patients with osteoporosis. ■ Patients with heart disease or wearing electronic medical devices such as a pacemaker. ■ People who have a fever. ■ Pregnant women or women on their menstrual period. ■ Patients who are injured or have a skin disease. ■ When unsupervised, any children are under the age of 14 and those unconscious are not allowed to use this product. ■ People who are told by their physicians to have rest or who feel unwell. ■ People whose bodies are wet are forbidden to use this product. ■ This product has a hot surface. Persons insensitive to heat must pay attention when using this product. ■ If the supply cord is damaged, to avoid danger, it must be replaced by a professional from the manufacturer, its maintenance department or similar department
---	---



Safety Precautions must be observed

Important safety warnings	
 Warnings	<ul style="list-style-type: none"> ■ Do not allow children to touch any movable part of this product. ■ Use the well-grounded power supply unit suitable for this product. ■ Pull out the plug after use or before cleaning to avoid any physical injury or damage to the product. ■ Operate this product as instructed in this manual. ■ Do not use any parts or accessories which are not recommended. ■ Do not use this product outdoors. ■ Please read the Operation Instructions carefully before operation. ■ Never use this product for any other purpose not listed herein. ■ 20 minutes of usage each time is recommended. ■ Do not use this product if the cover or leather is broken or damaged. ■ Do not drop anything into this product. ■ Never fall asleep while using this product. ■ Do not use this product if you are drunk or feel unwell. ■ Do not use this product within one hour after a meal. ■ Do not use this product with excessive force to avoid any injury.

Safety precautions	
 Caution	<ul style="list-style-type: none"> ■ Check whether voltage is consistent with the specification of this product. ■ Never insert or pull out the plug with a wet hand. ■ Do not let water flow into this product to avoid electric shock or cause damage to this product. ■ Do not pull the power cord when plugging or unplugging it. Rough handling is forbidden. ■ Do not damage the wire or modify the circuit of this product. ■ Do not clean live parts of this product with a wet cloth such as a power switch and plug. ■ Be away from this product in case of power failure to avoid any injury if power is restored suddenly. ■ Stop using this product at once while it works abnormal, and consult your local supplier. ■ Stop using this product if you feel unwell, and consult your health care practitioner.

Storage conditions	
 Caution	<ul style="list-style-type: none"> ■ Storage room temperature: 5 °C to 40 °C. ■ Relative humidity (RH) between 20% and 80%; free of corrosive gases, and a well-ventilated room.

Safety Precautions must be observed

Product service and maintenance	
 Caution	<ul style="list-style-type: none"> ■ This product should be maintained by the service center designated by the manufacturer only. No user should disassemble or maintain it without permission. ■ Do not forget to turn off the main power switch after usage. ■ Do not use this product if the power socket becomes loose. ■ If this product will be left unused for a long period of time, it is necessary to roll up the power cord of this product and store this product in a dry and dust-free environment. ■ Do not store this product at a high temperature or near open flame. Avoid prolonged exposure to direct sunshine. ■ Please clean this product with dry cloth. Never use thinner, benzene or alcohol. ■ The mechanical components of this product are specially designed and manufactured, so no special maintenance is needed. ■ Do not use a sharp object to stab at this product. ■ Do not roll or pull this product on any uneven ground. Instead, it should be lifted before moving. ■ Please use this product intermittently. Do not keep it working continuously for a long period of time.
Operating environment	
 Caution	<ul style="list-style-type: none"> ■ Do not use this product in a very moist environment such as the bathroom. ■ Stop using this product immediately when the ambient temperature changes sharply. ■ Do not use this product in any heavily-dusty or caustic environment. ■ Do not use this product in a small space or a place without good ventilation.
Solutions to ordinary malfunctions	
 Caution	<ul style="list-style-type: none"> ■ If the motor sounds during operation of this product, this is the normal operation sound. ■ If the controller cannot work normally, check whether the plug and the power socket are connected reliably, and whether the power switch is turned on. ■ If the rated working time is over, this product will automatically activate the power-off button; If this product keeps operating for a long period of time, the temperature protector will stop this product automatically. The product can be used again after half an hour.

Installation Parts

Controller bracket installation instructions

After the screw thread on the support knob of the controller rest assembly aligns to the screw thread position of the support mounting seat on the armrest of the massage chair, just turn clockwise and screw tightly for fixation.

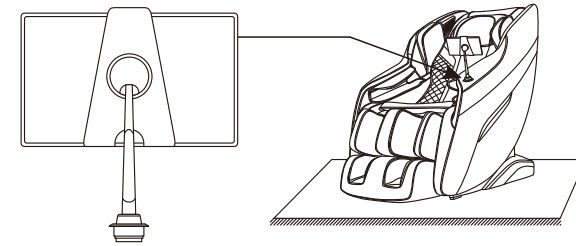

Calf installation instructions

1. After connecting the lower leg and the air tube on the massage chair with the wire harness, untie the fixed pipeline belt and insert the connecting part into the seat frame (Fig. 1).
2. Sleeve the lower leg fixing block on the round tubes on the left and right sides of the lower leg (Fig. 2).
3. Hang the lower leg sleeved with the fixing block on the hook of the massage chair seat frame (Fig. 3).
4. Fasten the lower leg on the massage chair with 4 M4 screws (2 on the left and 2 on the right). Check whether there is any abnormality in the up-and-down turning and whethe(Fig. 4).

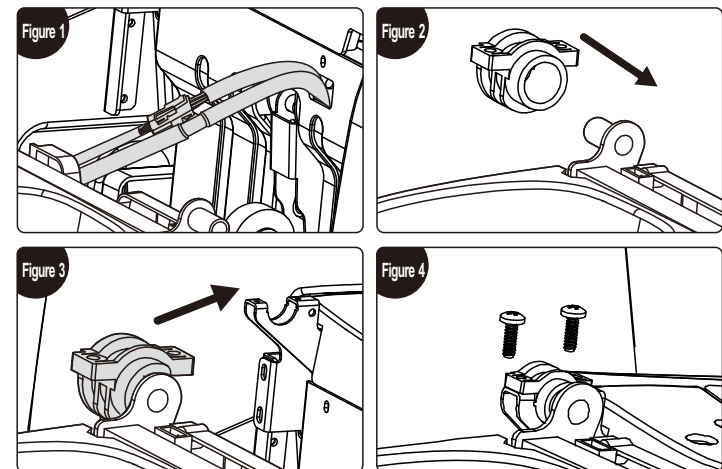

Place Massage Chair

Installation placement

Make sure there is enough space for the massage chair can be tilted at least 20 cm.



Do not expose the massage chair directly to high temperature environment due to sunlight (such as: in front of heating equipment), and place it to where can avoid high temperature and direct sunlight. It is recommended to lay a soft cushion for long-term use in a designated location. When laying the cushion, the size of the cushion should be enough to cover. Keep the range where the machine touches the floor and the range where your feet touch the floor.

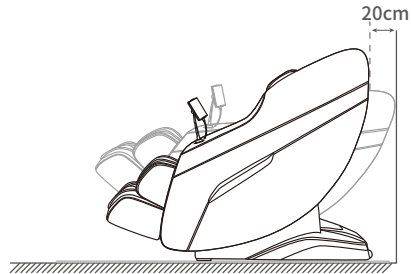

Product lift instruction

Require team work to lift and move the chair to avoid injury.



1. Please lift the massage chair to move it on vulnerable ground such as wooden floor.
2. When moving on a similar wooden floor, it is recommended to lift it. Avoid damage to the casters. When the floor is lifted and moved to the designated position, be careful to keep your hands out of the way to avoid injury, and be careful of your feet being crushed. Do not let go of the unit until the unit is completely flat, the floor may be damaged, therefore, it is recommended to place mats, etc. on the floor.

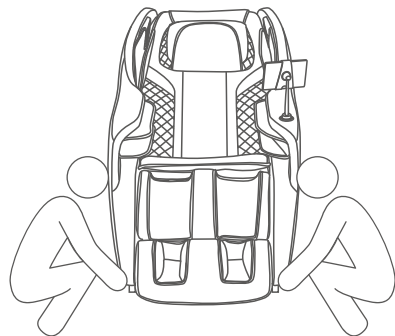

Place Massage Chair

Move method

Use the rear casters to move the massage chair. Move the chair by tilting it down and backward about 45° as shown in the diagram.

NOTE: Excessive force to title will cause the chair to tip over completely and product damage.



1. Before moving, please shut down the machine properly to reset the whole machine, and then cut off the power.
2. Please keep the chair vacant when moving. (People, pets or clutter will not be able to stay on the chair.)
3. When moving, do not cross a drop barrier higher than 2mm or a gap greater than 5mm.
4. When using casters to move this product, single continuous movement is not supported; if the distance exceeds 50 meters, please make this product move slowly and evenly.

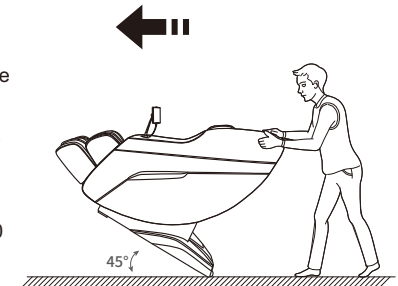

How to disassemble and use headrest cushion and backrest cushion

Using a headrest cushion can reduce the intensity of kneading massage on the neck and shoulders, and you can decide whether to use a headrest cushion according to your needs (recommended to use a headrest cushion). The backrest cushion and the backrest are connected by a zipper (1), and the headrest cushion and the backrest cushion are connected by a zipper (2).

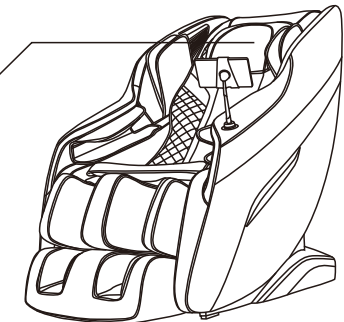
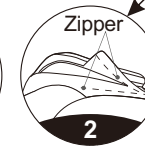

Before Use

Check around

Make sure that there are no people, pets and other objects around the unit.



Make sure there are no foreign objects in the gaps of the machine

Before massaging, make sure that no foreign objects are caught in the legs, feet, etc.

Under no circumstances allow hands, feet, and head to penetrate into the area between the lower leg mechanism and main body, or the area between the armrest and the capsule.

Under no circumstances should hands, feet, or head sink under the fabric or leather covering of the massage area.

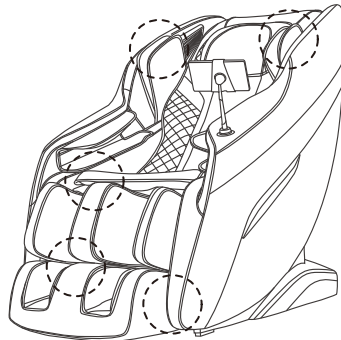

Before Use

Turn on the power



Plug in power cord

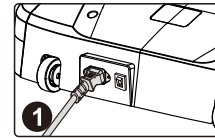

Schematic diagram of power on

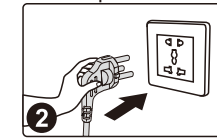

Turn on the power switch ("I" position)

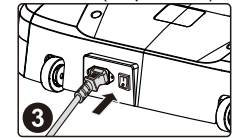

- Please check the power cord and plug for damage before use.
- Please supply power to this product in accordance with the working power requirements of this product's calibration.
- It is strictly forbidden to use a power supply other than the nominal power supply of this product.
- It is strictly forbidden to connect various power conversion devices without authorization to supply power to this product.

Product Structure

Parts description

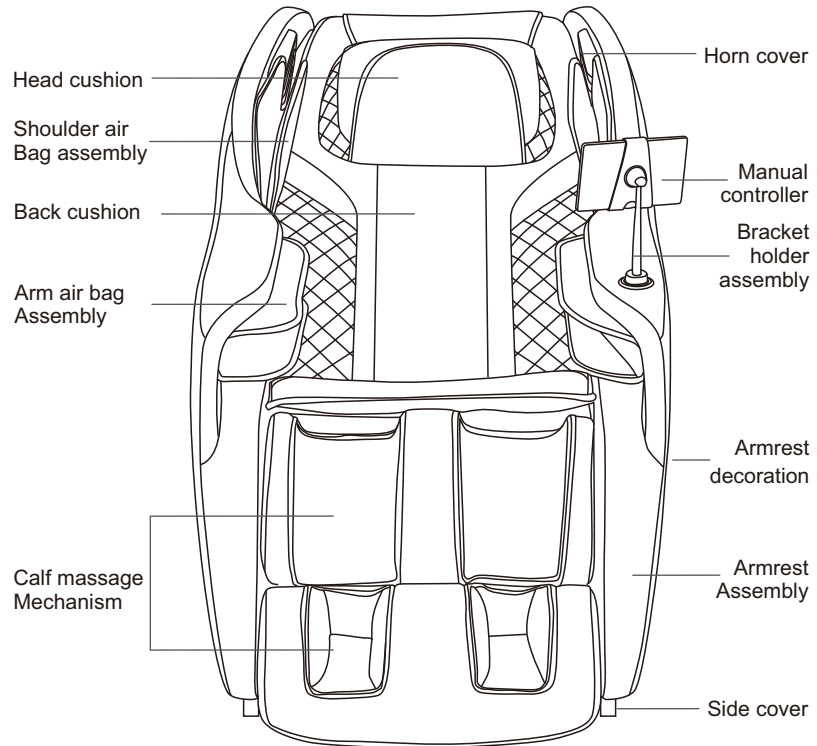

Product Structure

Function distribution

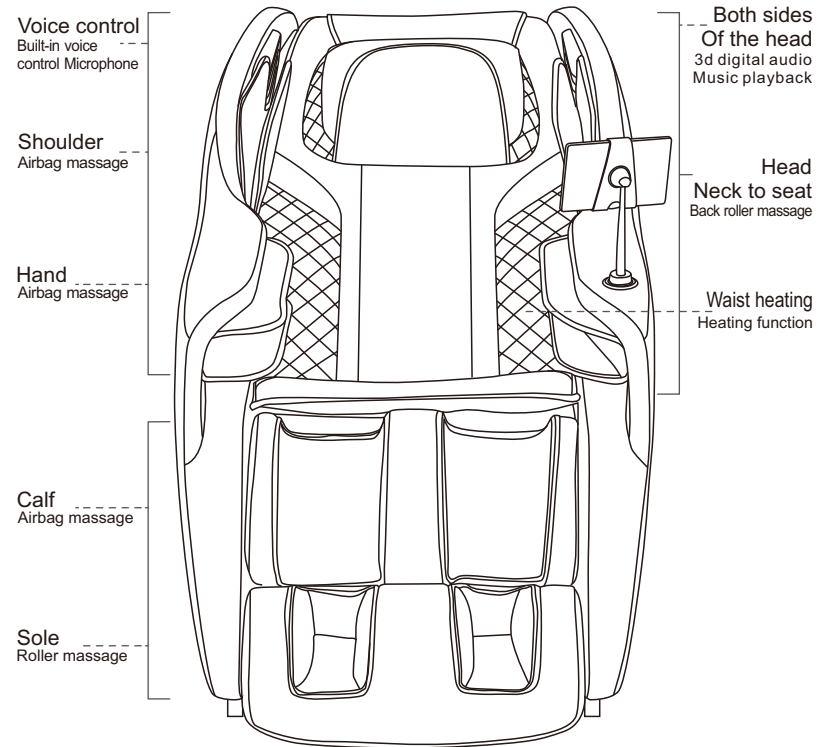

Product Structure

I . Introduction to the remote controller

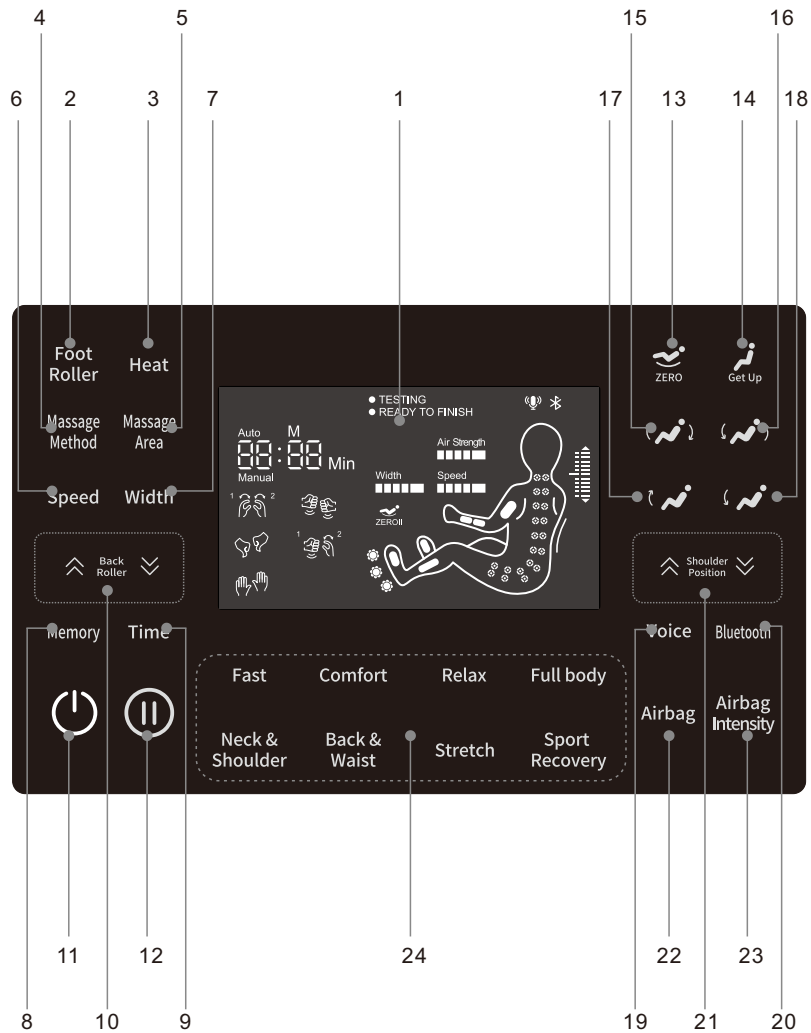

Product Structure





1. LCD: display all massage functions.
2. Foot roller:
 - Turn on or off the foot roller massage function, with a total of 3 levels that can be adjusted.
3. Heating: Turn the heating function on or off.
4. Massage Method:
 - There are five simulated massage method: Knead, Shiatsu, Tap, Knock, and Knead and Knock.
5. Massage position: There are five massage positions: Spot, Partial, Full, Upper and Lower.
6. Massage speed: Speed adjustment in manual mode. There are five levels.
7. Massage width:
 - Manual mode, there are three modes: Knead, Shiatsu and Tap. A total of three width options can be adjusted.
8. Memory:
 - Long press to store the currently running massage program, including massage technique, air mode and strength, position angle of calf frame and backrest frame, and other massage functions. One function can be stored.
 - Short press to call the previously saved massage program.
9. Timing:
 - Timing adjustment: 5 minutes to be added for each press, with the maximum 40 minutes. If 40 minutes are exceeded, it will return to the lowest time value.
10. Massage hand adjustment:
 - The upper and lower positions of massage hands can be adjusted in case of Spot and Partial.
11. Power key: Turn the massage chair on or off.
12. Pause: Pause or start the massage function.
13. Zero-gravity:
 - There are two zero-gravity modes and zero-gravity off, which can be cycled and switched as needed.
14. One-click Start: Return the massage chair to the sitting angle.
15. Seat-down: Adjust the backrest frame down and the calf frame up.
16. Seat-up: Adjust the backrest frame up and the calf frame down.
17. Calf-up: adjust the calf frame up.
18. Calf-down: adjust the calf frame down.
19. Voice control:
 - Short press: wake up voice control; long press for 3 seconds: turn on or off the voice control function.
20. Bluetooth: Turn Bluetooth on or off.
21. Shoulder position adjustment:
 - Manually adjust the position of human shoulder and massage the Shiatsu point.
22. Air position: There are three massage positions: Full, Upper and Lower.
23. Air intensity: the function of adjusting air intensity, the air intensity is adjustable with 5 levels.
24. Automatic mode: fast massage, comfort massage, relax massage, full body massage, neck and shoulder massage, back and waist massage, stretch massage and sport recovery.

Operation Instructions

II. Start massage

- ①. Press the power key  to start the massage.
- ②. Automatically adjust the angle.
- ③. Automatically detect human shoulder position, keep sitting posture fit with massage chair.
- ④. Conduct fine adjustment of shoulder position. If the detected position deviates from the actual shoulder position, adjust to the proper position by Up and Down keys for shoulder position. Shoulder position is adjustable of 10 gears. If no shoulder position adjustment within 10 seconds, the massage function will be started.

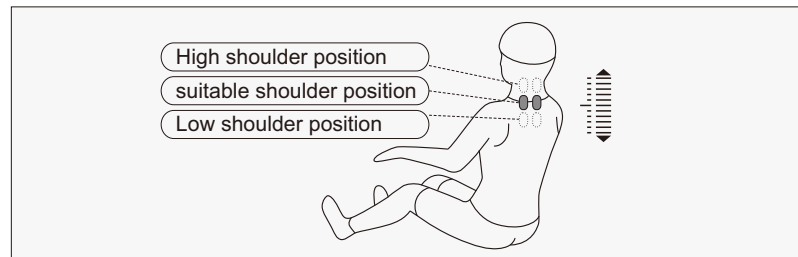

Note: The Auto function can be selected during the boot-up process and the massage can be directly started.

Button	Description	Display
 Shoulder position adjustment (Up key)	Adjust the massage ball position upward so that it reaches the proper shoulder position.	
 Shoulder position adjustment (Down key)	Adjust the massage ball position downward so that it reaches the proper shoulder position.	



In the process of shoulder position detection, the shoulder position adjustment icon is displayed on the screen of the manual controller and the "beep" sound of the manual controller is heard. At the same time, press the up and down keys of the shoulder position to adjust the shoulder position. At this time, you can also press 8 automatic massage function keys to enter this mode for massage (Step 4 can be skipped directly).

• Pause

Function	Button	Description	Display
Pause		When the massage function is running, press the "Pause" key to temporarily stop all massage functions; press the "Pause" key again to continue the massage function before the pause.	 Min









Operation Instructions

• Auto Massage

Function	Button	Description	Display
Auto Massage	Fast Massage	Quickly experience all massage effects.	Auto 01
	Comfort Massage	The most comfortable massage experience.	Auto 02
	Relax Massage	Gentle and comfortable deep massage, which can relieve body fatigue and relax the body.	Auto 03
	Full body Massage	Deep massage, which can revive body vitality.	Auto 04
	Neck& shoulder Massage	According to the unique neck and shoulder massage method, through effective massage of cervical spine and scapula, neck and shoulder pain can be relieved and neck and shoulder fatigue can be improved.	Auto 05
	Back& Waist Massage	Focus on the back and waist to relieve back and waist soreness.	Auto 06
	Stretch Massage	The lower leg frame and the backrest frame are lifted and lowered for stretching and traction of the leg and waist, effectively relieving tiredness, relieving joint soreness and restoring vitality.	Auto 07
	Sport Recovery	Quick recovery of body fatigue after exercising.	Auto 08



Operation Instructions

• Manual massage

Function	Button	Adjustment of massage ball	Display
Massage Method	Massage Method	Stop: Width.	/
		Knead: speed; 1 is clockwise knead and 2 is counterclockwise knead.	
		Shiatsu: speed and width	
		Tap: speed and width.	
		Knock: speed and width.	
		Knead&Knock: speed; 1 is clockwise Knead&Knock and 2 is counterclockwise Knead&Knock.	
Speed	Speed	Adjustable 5 gears in speed.	
Width	Width	Adjustable 3 gears in width.	
Massage Area	Massage Area	Fixed point: Massage in a fixed position.	H0
		Partial: Massage in a small area forth and back.	H1
		Upper back: Massage the upper back forth and back.	H2
		Lower back: Massage the lower back forth and back.	H3
		Full: massage the full body forth and back.	H4
		Massage position adjustment (in Fixed-Point and Partial mode, massage position can be adjusted).	Robot Up
			Robot Down

Operation Instructions

• Pneumatic massage

Function	Button	Description	Display
Airbag	Airbag	Full-body pneumatic massage: Massage the arms, upper arms, legs and feet with air pressure.	
		Upper body pneumatic massage: Massage the arms and upper arms with air pressure.	
		Lower body pneumatic massage: Massage the legs and feet with air pressure.	
		Turn off air massage	
Airbag Intensity	Airbag Intensity	Adjustable of 5 gears.	

• Heat massage







Function	Button	Description	Display
Heat	Heat	Press this key to turn on or off the heating function	

• Foot roller massage

Function	Button	Description	Display
Foot Roller	Foot Roller	Press this key to turn on / off sole roller massage and it is adjustable of three gears in intensity, namely weak, medium and strong, it can be switched cyclically among three gears and off states.	

Operation Instructions



· Angular adjustment

Function	Button	Description
Seat-up key		Press and hold this key, the backrest frame rises slowly, the calf frame descends slowly, accompanying the sound of "beep... beep..." until reaching the top, if the key released the frames stop.
Seat-down key		Press and hold this key, the backrest frame moves down slowly, the calf frame moves up slowly, accompanying the sound of "beep... beep..." until reaching the bottom. If the key released the frames stop.
Calf frame Up		Press and hold this key, the calf frame rises slowly accompanying the sound of "beep... beep..." until reaching the top, if the key released the frames stop.
Calf frame Down		Press and hold this key, the calf frame moves down slowly, accompanying the sound of "beep... beep..." until reaching the bottom, if the key released the frames stop.
Auto Seat-down		Every time the key is pressed, it will be switched to next automatic seat-down mode, there are two kinds of automatic modes as well as Off mode, which are switched cyclically.
Get up		Restore the massage chair to the sitting angle.

· Voice control

Function	Button	Description	Display
Voice control	Voice	Short press to wake up the voice control function	/
		long press for three seconds to turn on or turn off the voice control function.	

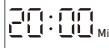
· Other manual functions

Function	Button	Description	Display
Timing	Time	For timing adjustment, every time you press the key, it increases by 5 minutes, but cannot be increased to more than 40 minutes, and it returns to the lowest time value if more than 40 minutes.	 Min
Memory	Memory	Long press to store the currently running massage program, including massage technique, air mode and strength, position angle of calf frame and backrest frame, and other massage functions. One function can be stored. Short press to call the previously saved massage program.	M
Bluetooth	Bluetooth	Turn on or off the Bluetooth function.	

Operation Instructions

III. Voice Control Mode

- When the massage chair is turned on or in standby mode, the sound "Hi Alice" or "Hey Alice" will be produced to enable the voice control function. Alternatively, you can press the voice control button armrest to enable the voice control function.
- Long press the Voice control button 3 seconds to turn on or off the voice control function.
- After such function is enabled successfully, the massage chair will reply "I am here." At this moment, once a corresponding voice control entry to be implemented is given within six seconds, the corresponding voice control function can be performed after a reply is received from the massage chair; if no correct voice control entry is given within six seconds, the voice control function automatically will be off automatically and needs to be enabled again.
- Note: When waking up the voice control function, please use English, the speech rate is moderate, Voice commands should be follow up the Voice entry.

Voice Control Entry		
Entry: "Hi Alice" or "Hey Alice". Answer: I am here.		
No.	Voice control entry	Answer entry
1	Massage on	Answer: Ok, massage on
2	Massage close	Answer: Ok, massage close
3	Comfort massage	Answer: Ok, comfort massage
4	Relax massage	Answer: Ok, relax massage
5	Full body massage	Answer: Ok, full body massage
6	Neck and shoulder massage	Answer: Ok, neck and shoulder massage
7	Back and waist massage	Answer: Ok, back and waist massage
8	Stretch massage	Answer: Ok, stretch massage
9	Fixed massage	Answer: ok, fixed massage
10	Change the other mode	Answer: Ok, change the other mode
11	Go little down	Answer: Ok, go little down
12	Go little up	Answer: Ok, go little up
13	Open the air pressure	Answer: OK, Open the air pressure
14	Close the air pressure	Answer: OK, , Close the air pressure
15	Up the seat position	Answer: Ok, Up the seat position
16	Down the seat position	Answer: Ok, Down the seat position
17	Stop adjustment	Answer: Ok, stop adjustment

Operation Instructions

IV. Operation Instructions for Bluetooth Speaker Play

1. Enter the smart device main menu. Open "Settings" and select the "Bluetooth" option. Open "Bluetooth", and Bluetooth will automatically "Search for a New Bluetooth Device".
2. The smart device will search for the corresponding Bluetooth model (e.g. IMCM-XXXX). Click the "Match" button. If you are asked whether to match with the device, you just select "Match" to complete matching.
3. Turn on "Music Player" in the smart device and select the song to play.

V. Massage close

During the massage, press the hand control switch key "⏻" to turn off. Will immediately turn off all massage functions, reset the backrest and leg, or when the massage time is up, the massage automatically turns off all massage functions, and the backrest mechanism and leg mechanism do not reset.

Cut off the power supply of the whole machine, as shown in the attached picture (the schematic diagram of the power cut off of the whole machine).

Turn off the power switch ("0" position)

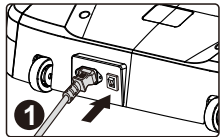

Schematic diagram of unplugging the power plug

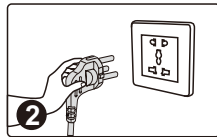

Unplug the product from the power cord

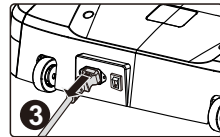

Cleaning And Maintenance

Cleaning synthetic leather and plastic parts

Wipe the leather with a soft, dry cloth.

- Do not use chemicals such as thinner, gasoline, alcohol, etc. to clean the unit.
- When using commercially available leather care products (rags), please follow the instructions for use.
- If synthetic leather is particularly dirty, wipe it in the following way.
 - ① Immerse a soft cloth in water or hot water containing 3% to 5% neutral detergent, then wring it out thoroughly.
 - ② Use the above soft cloth to wipe the leather surface.
 - ③ Wipe off the cleaning solution with a cloth soaked in clean water and thoroughly wrung out.
 - ④ Wipe with a wrung soft cloth.
 - ⑤ Let it air dry naturally.
- When it is difficult to remove stains, please immerse commercially available melamine foam in neutral detergent, and then wipe the machine with it.
- Do not use a hair dryer to dry the surface.
- Be careful when wiping the machine with denim and colored fabrics, as the color of the fabric will stain the surface of the synthetic leather.
- Do not keep these parts in contact with plastic for a long time, as this will cause discoloration.
- Synthetic leather may be discolored, so when using hair dye, please cover the touched part with a towel.

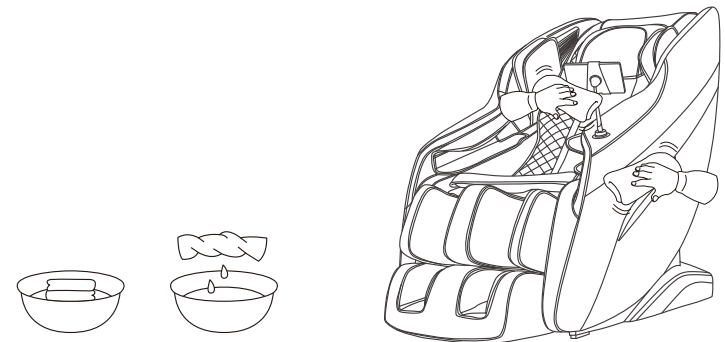

Troubleshooting

Fault	When the calf mechanism or the backrest reaches a certain position, press the corresponding adjustment button and it will no longer change, and a continuous "beep, beep" sound will be emitted.
Solution	Due to product structure design and ergonomic requirements, this product has a limited protection design for the limit state of attitude adjustment. At the same time, a reminder sound will sound when the limit is reached.

Fault	The function does not work or some functions do not work after the machine is turned on.
Solution	After the machine is turned on by pressing the switch key, it is necessary to manually select an automatic massage program or other working state. If it is not operated, the machine will automatically shut down after 20 minutes. If the manual operation mode is selected, the functions that are not selected may be disabled, and the working mode needs to be manually set in the manual mode.

Fault	The machine makes a leather rubbing sound when adjusting its posture.
Solution	This product adopts high-grade anti-corrosion leather that meets environmental protection requirements. Due to the inherent characteristics of leather materials, there will be a normal slight noise when rubbing at the relative movement, which is a normal phenomenon. Note: If you hear fabric or leather tearing sound when the machine is running, please stop using it immediately and seek professional maintenance.

Fault	The massage wheel did not reach the shoulders or neck.
Solution	If the head does not touch the head cushion or the back does not touch the backrest, the shoulder position may be lower than the actual position during the body shape detection process. Sit in the deepest position of the seat, rest your head on the headrest, and start over from the beginning.

Fault	The unit is damaged. The power cord or power plug is abnormally hot.
Solution	To prevent accidents, be sure to contact an authorized service center.

Please feel free to contact the designated service personnel for any questions or doubts about this product.

Product Specification

Model: A229-2

Name: Massage Chair

Rated voltage: 110-120V~ 60Hz
220-240V~ 50Hz/60Hz

Rated power: 90W

Rated time: 20min

Safety structure: Class I