

iRest

A802 MASSAGE CHAIR

Operation Instructions

SAVE THESE INSTRUCTIONS



I REST HEALTH SCIENCE AND TECHNOLOGY CO., LTD
HAOZHONGHAO HEALTH SCIENCE AND TECHNOLOGY CO.,LTD.
ZHEJIANG HAOZHONGHAO HEALTH PRODUCT CO.,LTD.
<http://en.iRest.com> E-mail: iRest@iRest.com

※Products refer to the actual product, without prior notice.

Thanks for purchasing this product. Please read this manual instruction carefully in order to know how to use this product correctly before operation. Please pay more attention to some important safety warning and keep this manual book properly for future use.

Note: Our Company reserves the right to revise the design and description of this product without any further notice. Please refer to the actual color of this product.

CONTENTS

Safety and maintenance	02-03
Use safety warning	04-05
Name and function of components	06
Function	07-08
Remote interface introduce	09-10
Method of usage	11
1.Switch power supply on	11
2.Second, the hand control massage function control operation	11-31
3.Turn off power, stop massage	31
4.Fourth, support Apple and Android tablet system, operation control massage chair	32
5.Five, tablet system operation, turn on the whole machine power	33
6.Sixth, tablet computer massage function control operation	34-44
7.Seven, tablet system operation, turn off the power, end the massage	44
8.Eight, handrail installation instructions	45-46
9.Nine, calf installation instructions	47-48
10.Ten, aromatherapy installation instructions	49
11.Head cushion and backrest pad's dismounting and use manual	50
12.Floor protection	50
13.Method of movement	51
Product specification	52

Safety and maintenance

1. Important Safety Warning.

- Don't allow children to touch moveable part of this product.
- Please use well-grounding power supply suited to this product.
- Please pull out the plug after use or before cleaning to avoid injury or Damage to the product.
- Please operate this product according to this manual instruction.
- Don't use accessories which are not recommended.
- Don't use this product outdoors.
- Please read this manual instruction carefully before operation.
- Any other usage that is not listed in this manual instruction is forbidden.
- 20 minutes of usage each time is recommended.
- Please don't use it if the leather is broken or damaged.
- Please don't use it if the cover or leather is damaged.
- Please don't use it if the radiator hole is covered or blocked.
- Please don't drop anything into this product.
- Please don't fall asleep while using this product.
- Please don't use it if drunk or feel unwell.
- Please don't use it within one hour after having meal.
- Please don't make the massage function too strong for avoiding Injury.

2. Environment for usage.

- Please don't use it under high temperature and moist environment such as bathroom.
- Please don't use it immediately while the environmental temperature changes sharply.
- Please don't use it under heavy-dusty or caustic environment.
- Please don't use it where there is not enough space or not good ventilation.

3. People who are not suitable to use this product.

- People who are suffering from osteoporosis are not suitable to use this product.
- People who are suffering from heart disease or carrying electronic medical equipment such as heart pacemaker are not suitable to use this product.
- People who are suffering from fever are not suitable to use this product.
- Pregnant women or women that are in menses period are not suitable to use this product.
- People who got injured or skin disease are not suitable to use this product.
- Children under 14-year old or people mentally unbalanced without being Supervised are not allowed to use this machine.
- People who are told by doctor to have rest or people who feel unwell are not suitable to use this product.
- People whose bodies are wet are forbidden to use this product.
- The appliance has a heated surface. persons insensitive to Heat must be careful when using the appliance.

4. Safety.

- Check the voltage if it is suitable to the specification of this product.
- Don't use wet hand to pull the plug.
- Don't make water go inside this product to avoid electric shock or cause damage to this product.

Safety and maintenance

- Don't damage the wires or change the circuit of this product.
- Don't use wet cloth to clean the electric parts such as switch and plug.
- Be away from this product under power cut state to avoid injury if the power comeback suddenly.
- Stop using this product while it works abnormal, and please consult local agent immediately.
- Stop using this product if you feel unwell, and please consult health care doctor.
- This appliance is not intended for use by persons (including children) with reduced physical, sensory or mental capabilities, or lack of experience and knowledge, unless they have been given supervision or instruction concerning use of the appliance by a person responsible for their safety.
- Children should be supervised to ensure that they do not play with the appliance.
- If the supply cord is damaged, it must be replaced by the manufacturer, its Service agent or similarly qualified persons in order to avoid a hazard.

5. Maintenance.

- This product should be maintained by certain appointed agents, users are prohibited to disassemble or maintain by themselves.
- Please don't forget to cut the power after usage.
- Don't use this product if the socket looses.
- If this product will be left unused for long, please curl up the wires and reserve this product in dry and dustless environment.
- Don't reserve this product under high temperature or near fire and avoid longtime direct sunshine.
- If the detachable cord / supply cord is damaged, it must be replaced by the manufacturer, its service agent or similarly qualified persons in order to avoid a Hazard.
- Please clean this product by dry cloth. Don't use thinner, benzene or alcohol.
- The mechanical components of this product are specially designed and made, it is not necessary to be specially maintained.
- Don't use edged res to thrust this product.
- Don't roll or pull this product above uneven ground, it should be lifted before moving.
- Please use it intermittently; don't make this product work continuously for long.

6. Solution of ordinary malfunctions.

- It is nature movement voice if the motor sounds while in usage.
- If the controller can't work normally, please check the plug and socket if they are connected strongly and make sure the switch is turned on.
- If the rated working time is over, the product will automatically activate the power-off button; If this product works continuously for long, the temperature protector will make the product automatically power-off, it should be used again after half an hour's rest.

Use safety warning

⚠ Warning

- When the footrest lifting, people should not apply pressure on the footrest to avoid the massage chair falling forward to damage the product or cause personal injuries

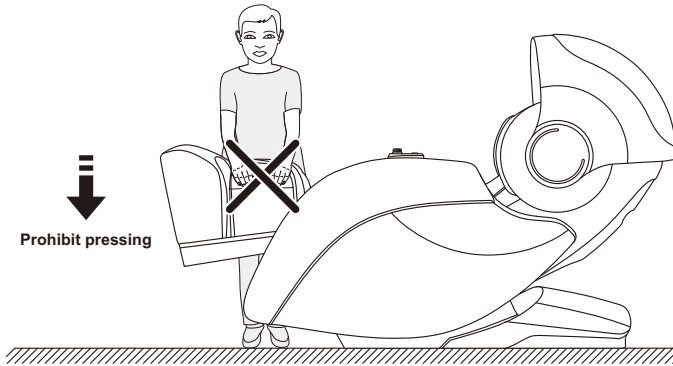

⚠ Warning

- Before sitting on the massage chair, Please make sure the massage hand cannot place in the seat position, so as avoiding the massage hand to damage the product or cause personal buttocks injuries.

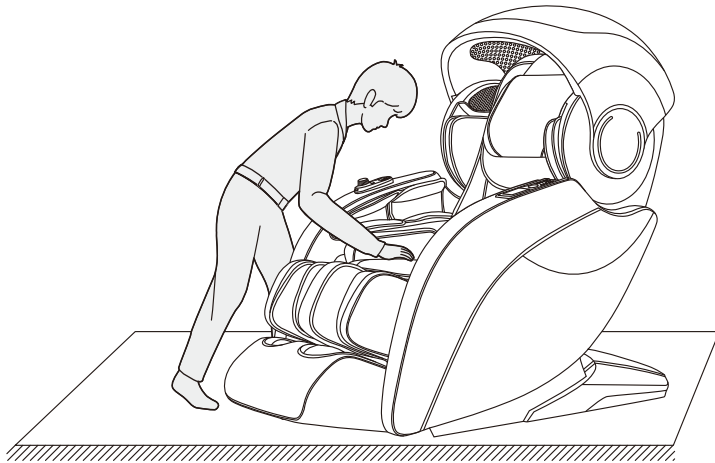

Use safety warning

⚠ Warning

- Do not strive to pull out the control cable or power cord during standby or power-on state to avoid product damaged or electrocution accidents. Advise you unplug the controller cable and power cord and put away after you use the chair.

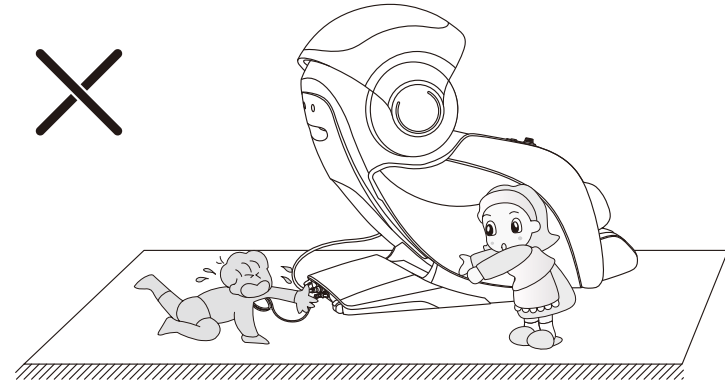

⚠ Warning

- When turning on the zero-gravity lying function, be sure to notice whether there are children or pets under the massage table under the bottom of the calf and the backrest to stay or play to avoid product damage and personal injury.

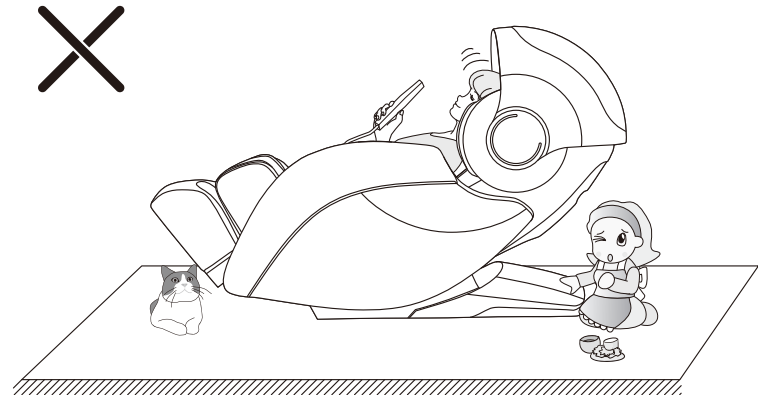

Name and function of components

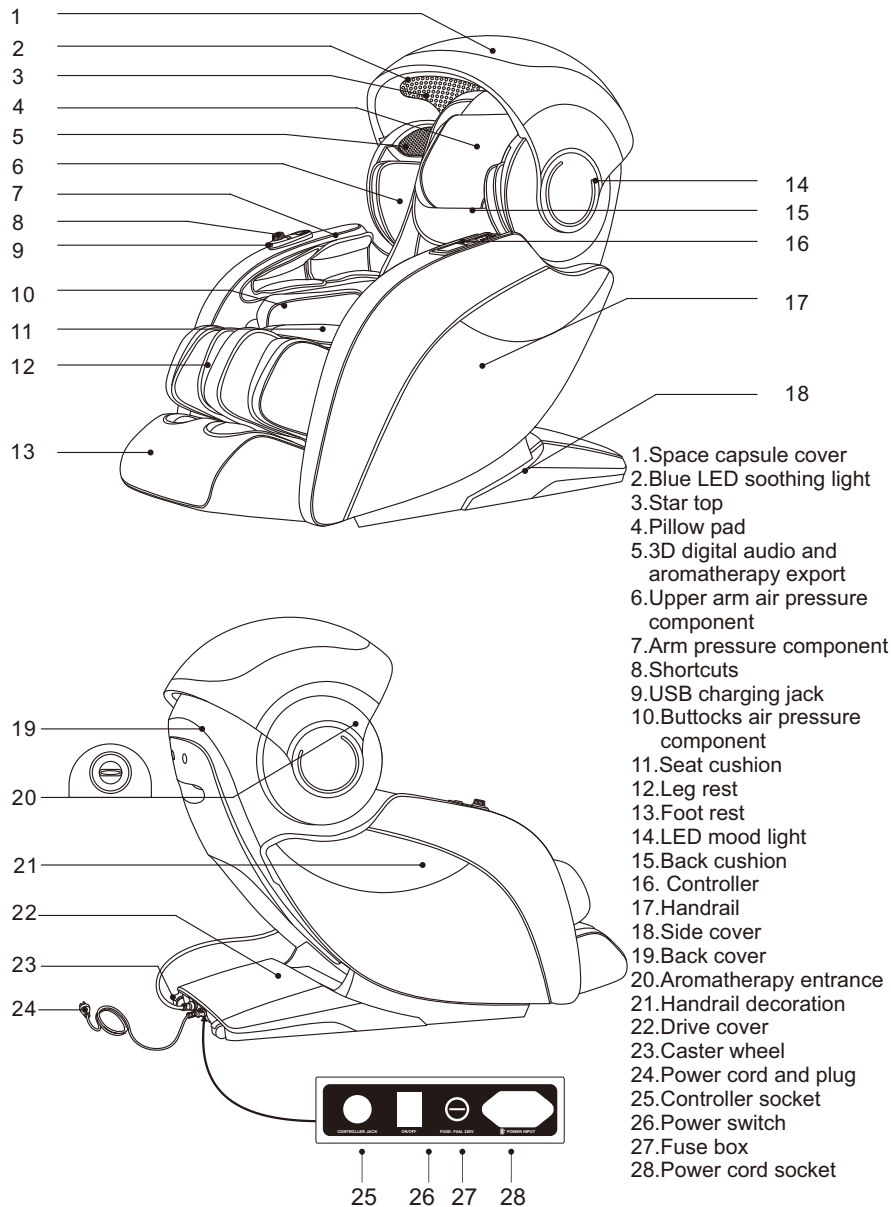

Function

- This product is designed with a set of intelligent 3D massage hand that can walk up and down, front and rear telescopic, and silent design
- The design has automatic detection and micro-adjustment function of the shoulder position; the human body curve and the automatic detection function of the massage finger pressure point automatically adjust the amount of the front and rear movement of the manipulator according to the detected human body curve and the massage finger pressure point, so that the massage is more humanized and scientific.
- Features automatic massage function: six kinds of automatic massage functions such as Shujing Active, Beautiful Butt Shaped, Sleeping Massage, Neck and Shoulder Relaxation, Back Stretching and Breathing.
- There are three special massage functions: Blu-ray bath, fragrant health, music SPA.
- There are three kinds of custom storage functions: Custom Storage I, Custom Storage II, Custom Storage III.
- The upper body manually selects the massage function: there are five kinds of massage position selections such as full stroke, partial, fixed point, upper back and lower back; shoulder lifting, kneading, tapping, shiatsu, kneading and tapping synchronization and 3D six massage techniques; The massage technique has five speeds that can be adjusted; in the state of tapping and shiatsu massage, the robot massage ball has five widths to adjust.
- With air pressure massage function: arm air pressure massage function (built-in 8 airbags), upper arm air pressure massage function (built-in 4 airbags), back air pressure massage function (built-in 4 airbags), leg air pressure massage function (built-in 22 Airbag), foot air pressure massage function (built-in 18 capsules), air pressure massage function on both sides of the seat cushion (12 airbags built-in), seat cushion air pressure massage function (built-in 4 airbags), and third-speed air pressure intensity adjustment.
- It features back heat therapy and leg heat therapy: carbon fiber is used as a far infrared heat source.
- The backrest frame is laid down with slide rail technology to keep the backrest away from the wall at all times, saving space.
- It has a waist swing massage function: it uses the waist pressure to swing around to form a twist massage function, which relieves sedentary and causes waist muscle tension.
- Shortcut button on the right armrest: open button, backrest and calf position adjustment button, heating button, star top button, aroma button, zero gravity button, calf extension button, calf shortening button, air pressure mode button, automatic mode button, etc. hot button.
- It has two kinds of adjustment functions: lower leg lifting adjustment, linkage lifting adjustment, zero gravity I or zero gravity II.

Function

- The foot is equipped with a foot roller massage function. The two sets of rollers roll and scrape the foot and the foot, and the heel has a number of massage bumps to massage the heel.
- The calf is equipped with the function of automatically detecting the length of the foot. When the calf is raised or lowered to a suitable angle, the calf will detect the length of the foot and detect the most comfortable massage part.
- The backrest guide adopts the curved guide rail technology, which fully fits the curve of the back of the human body, and can enjoy the body massage from the head to the thigh.
- There are 8 natural energy magnets in the leg airbag belt.
- Configure the LED mood lights on the left and right upper arms.
- A USB charging function is provided on the right armrest.
- It has a space capsule cover that rotates up and down.
- It features a blue sky treatment for starry sky.
- Aromatherapy function
- Configure TFT color screen hand controller
- Smart terminal devices (such as mobile phones or tablets) can use the APP software to control the massage chair via Bluetooth.
- Built-in 3D digital audio on the upper arm, Bluetooth music function, you can also connect your favorite music through Bluetooth (Bluetooth name: IMCM-XXXX) via smart device (such as mobile phone or tablet).
- The headrest cushion is double-layered, and the number of layers can be determined according to your needs, so as to reduce the neck and shoulder massage, which is suitable for different people to choose.

Remote interface introduce

Controller display section

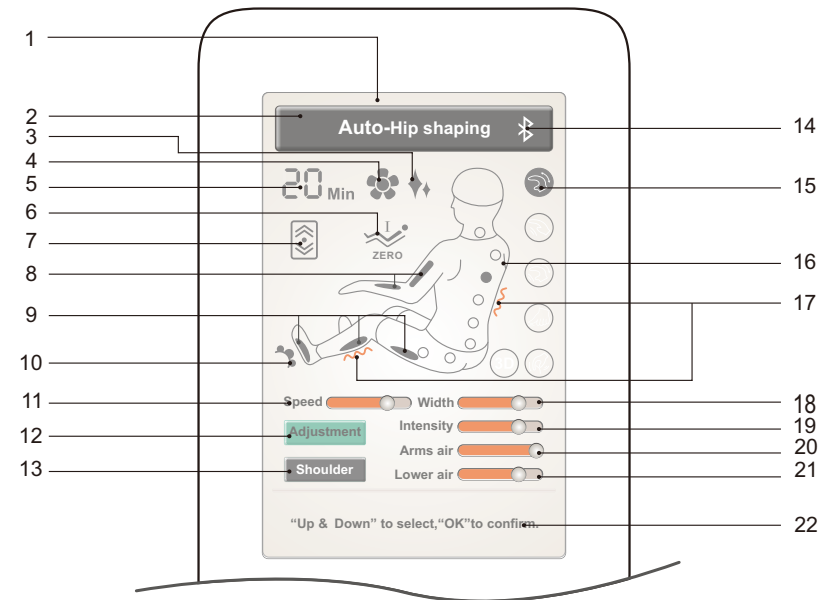

Note: The manual display shows the color, massage function and massage function icon layout order, please refer to the physical display!

- | | |
|----------------------------------|------------------------------------|
| 1. TFT LCD display | 12. Adjust |
| 2. Massage function status bar | 13. Shoulder position adjustment |
| 3. Star top display | 14. Bluetooth display |
| 4. Aromatherapy display | 15. The method display |
| 5. Time display | 16. Massage position display |
| 6. Zero gravity display | 17. Hyperthermia display |
| 7. The back stretch display | 18. Width adjustment |
| 8. Arm pressure display | 19. Massage intensity adjustment |
| 9. Leg and foot pressure display | 20. Arm pressure adjustment |
| 10. The foot roller display | 21. Lower body pressure regulation |
| 11. Speed adjustment | 22. The information bar |

Remote interface introduce

Controller button section

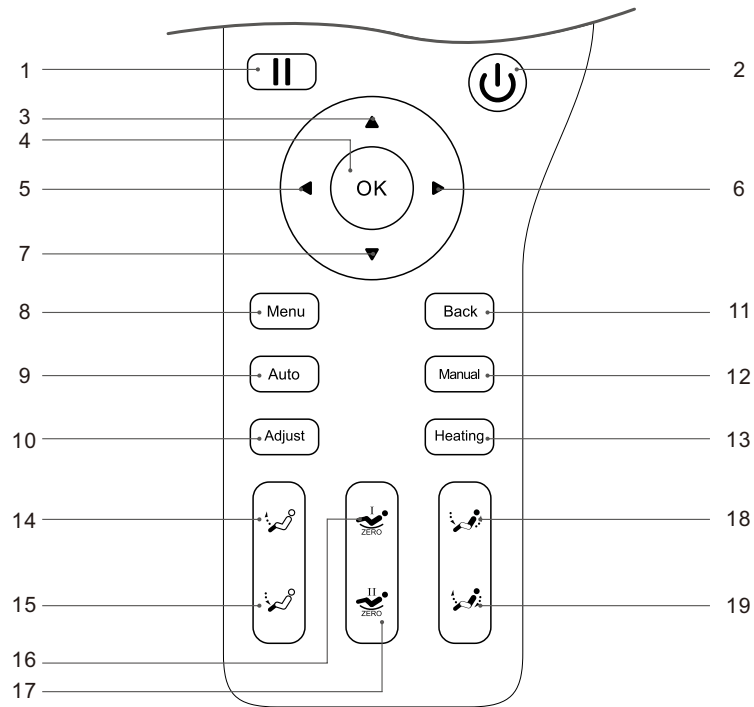

1. Pause button: Pause the current function.
2. Power button: Open and close the massage chair.
3. Up button: The navigation button is up.
4. Confirmation button: Confirmation button.
5. Left button: The navigation button is to the left.
6. Right button: The navigation button is to the right.
7. Down button: The navigation button is down.
8. Menu button: Enter the main menu interface.
9. Automatic button: enter the automatic mode selection interface.
10. Adjustment button: Enter the adjustment function selection interface.
11. Back button: Return to the function information interface.
12. Manual button: Enter the manual function selection interface.
13. Heating button: Turns the heating function on or off.
14. The calf rise button: adjust the calf rise.
15. The calf down button: adjust the calf down
16. Zero gravity 1 button: massage chair angle adjusted to zero gravity 1.
17. Zero Gravity 2: The angle of the massage chair is adjusted to zero gravity 2.
18. Stand up button: massage chair linkage stand up.
19. Lying on the button: massage chairs linked to lie down.

Method of usage

1. Switch power supply on

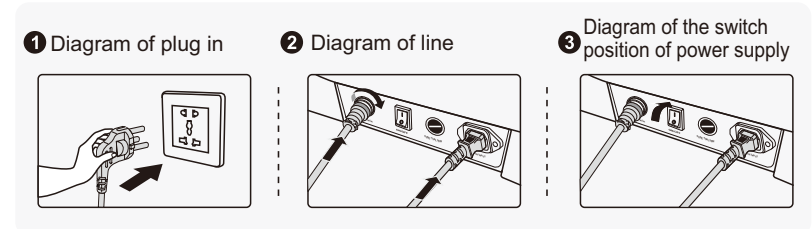

2. Second, the hand control massage function control operation

1). Standby

- After the massage chair is powered on and off, it cannot enter any mode operation in standby mode. Except for settings.



2). Start massage (Power button)

- Press the power button to start the massage, the backrest keeps the default position, the calf is slightly raised, waiting for the automatic mode to start the massage, the automatic mode is not selected within 5 minutes, and the massage chair automatically shuts down.

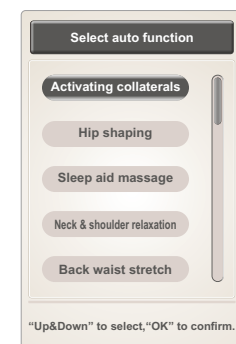
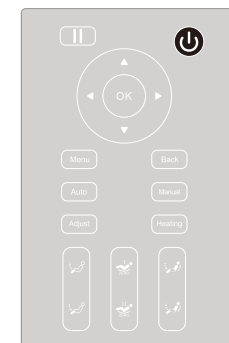



Method of usage

- When you select any of the automatic modes, the backrest and calf position will be adjusted to the set angle.
- After adjusting the angle, the massage chair automatically performs the shoulder position and body shape detection (Note: Shujing Active only detects the shoulder position, other modes are full body type detection and shoulder position detection), waiting for the test to be completed. If you press the "Enter" button, skip the shoulder position and body type detection steps, and directly turn on the default value to start the massage.

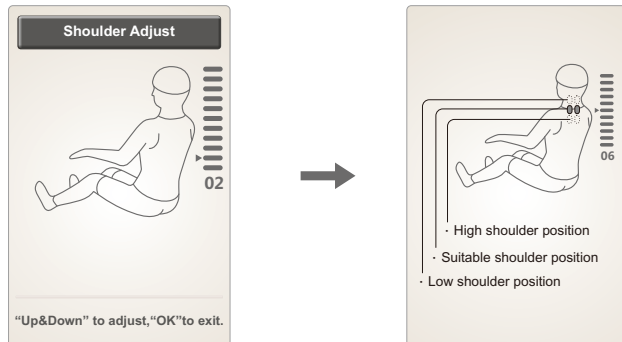

- After detecting the shoulder position, the buzzer prompts "Drip". If it is different from the actual shoulder position, you can adjust it to the appropriate position by pressing "Up" or "Down". The shoulder position is adjustable in 11 steps. With no shoulder position adjustment within 10 seconds, the massage function is automatically entered. Or press the "Enter" button to enter the massage immediately. Or the shoulder position is not detected, then the default shoulder position height is massaged.



Button	Description
	Move the massage balls upward to a suitable position.
	Move the massage balls downward to a suitable position.

- Under the current interface, you can use the navigation button to select "Adjust" or "Shoulder Position". After selecting the function to be set, press "Enter" to enter.

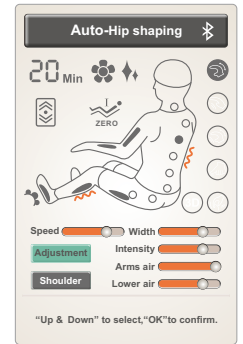

3).Pause button

- While the massage function is running, press the "Pause button" to temporarily stop all massage functions; press the "Pause button" again to continue the massage function before the pause. If the pause time exceeds 20 minutes, all massage functions are automatically turned off.

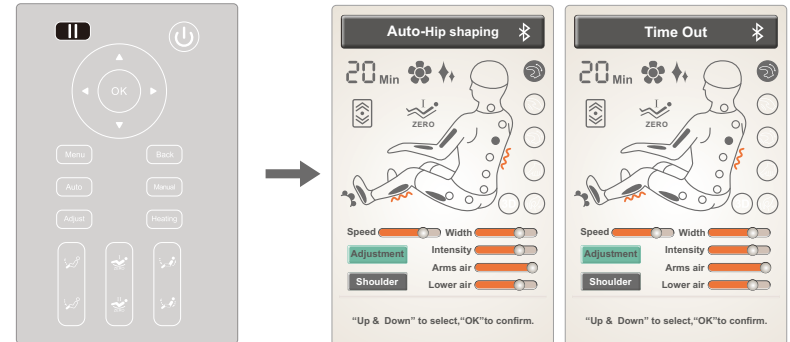

4).Menu button

- Press "Menu" to enter the main menu message function selection interface, including automatic program, special message, manual mode, adjustment, customization, setting, device data and other functional interfaces.
- Press "Up" or "Down" to select the massage function, press "Enter" to confirm the selected massage function. Press "Back" to return to the selection function running status information interface

Method of usage

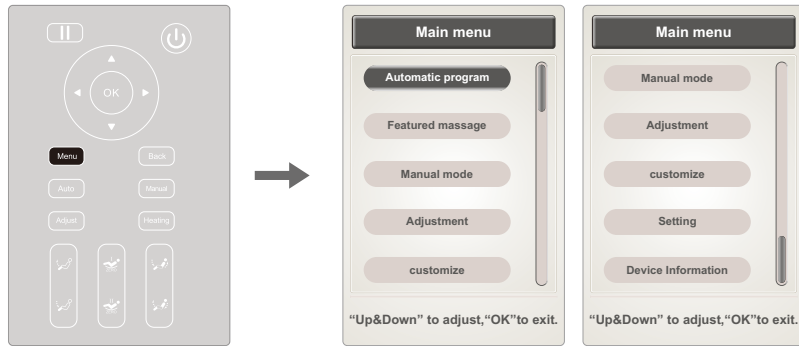

5).Automatic function (automatic button - can also directly press the “automatic button” to enter the automatic function interface)

- Press “Menu” to enter the main menu interface and select the automatic function icon: In the automatic mode, there are six automatic massage modes including Shujing Active, Beautiful Butt Shaped, Sleeping Massage, Neck and Shoulder Relaxation, Back Waist Stretching and Breathing.
- Press “Up” or “Down” to select the massage function, press “Enter” to confirm the selected massage function. Press “Back” to return to the selection function running status information interface.

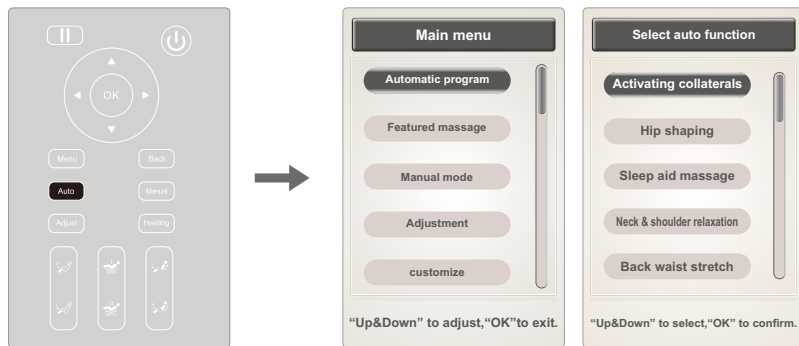

Note: The automatic function has been selected and displayed in the status bar of the massage function. You can press the “back button” to view it operating status.

Method of usage

Function	Description
Activating collaterals	Activating collaterals massage function is mainly used to massage the neck, shoulder, back, waist, buttocks, etc. by means of massage, finger pressure, squatting and tapping; and combined with the foot roller and the leg airbag squeeze type, The body is fully massaged. Effectively promote the body's meridians, eliminate fatigue, promote blood circulation, improve the body's immunity, relieve muscle fatigue and soreness. Relax, relieve stress and improve sleep quality. At the same time, it is accompanied by a voice broadcast to explain the function of Shu Jing active massage.
Hip shaping	Taking the buttocks as the massage focus, the hips are shaken and shaken, and the airbags are squeezed together. The hips are swayed and squeezed to effectively relieve the muscles of the buttocks, regulate blood circulation, tighten the buttocks. . Swinging jitter consumes excess fat and elasticity, making the buttocks muscles strong and body-building, with a beautiful arc to reach the perfect female curve beauty.
Sleep aid massage	With a light and gentle method, deep massage on the human body can effectively improve sleep and improve sleep quality, conditioning the body balance, relaxing body and mind, soothe sleep.
Neck & shoulder relaxation	Focus on the neck and shoulders, lift the neck, knead, shoulder beat, smash and other methods on the neck and shoulders massage. It has open and occluded neck and shoulder, activating blood circulation and relieving pain, and relieving neck and shoulder pain.
Back waist stretch	With the back of the back as the massage focus, the back of the back with a shiatsu massage, tamper, back traction and other massage hands the method effectively clears the back and waist meridians, promotes the circulation of the back and back, and relieves the fatigue and soreness of the lumbar muscles.
Breath conditioning	The breath conditioning massage function is mainly combined with kneading, massage, tampering, tapping, lifting and waist balloon extrusion. The neck, shoulders, back and waist massage of the human body, in which the neck and shoulders are mainly kneaded, lifted, smashed and other massage techniques, can alleviate the long-term head or overwork and lead to stiff muscles, soreness and elimination of the neck and shoulders. fatigue. The back waist is mainly based on finger pressure, squeaking and massage. It can dredge the back and meridians, promote blood circulation in the waist and improve back pain. At the same time, relieve anxiety, calm emotions, regulate the breath, and quickly sleep as a dream.

Method of usage

01).Automatic function (featured message)

- Press "Menu" to enter the main menu interface, select the special message function icons: including blue bath therapy, incense health, music SPA and other three special message modes.
- Press "Up" or "Down" to select the message function, press "Enter" to confirm the selected message function. Press "Back" to return to the selection function running status information interface.

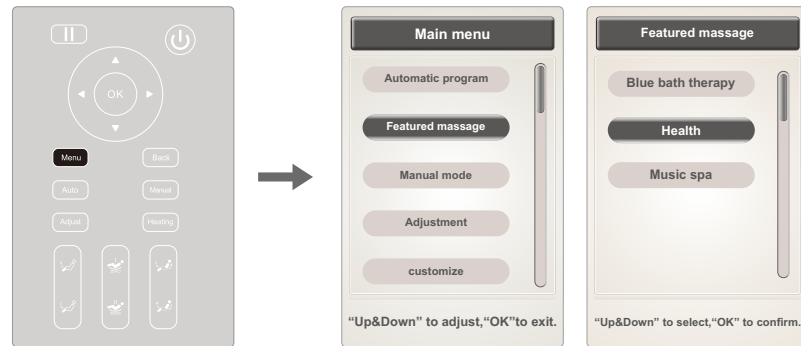

Function	Description
Blue bath therapy	After the blue bath massage function is turned on, the massage chair automatically lies, so that the human body maintains zero gravity, and then cooperates with the blue bathing function on the top of the starry sky. The blue can slow down the heart rhythm, adjust the balance, and eliminate the tension, with the starry sky LED The light and dark adjustment, the user with the light conditioning breathing combined with gentle kneading massage techniques to relieve the body and mind, release stress, relieve fatigue.
Health	After opening the fragrant health massage function, the massage chair is automatically lying down, so that the body is in a state of balance and relaxation, and then combined with massage and air pressure to massage the body in all directions, combined with the unique aromatherapy, the aroma can make people Balance emotions, relax, help sleep, relax muscles, balance body and mind
SPA Music spa	After opening the fragrant health massage function, the massage chair is automatically lying down, so that the body is in a state of balance and relaxation, and then combined with massage and air pressure to massage the body in all directions, combined with the unique aromatherapy , the aroma can make people Balance emotions, relax, help sleep, relax muscles, balance body and mind

Method of usage

6).Manual (Manual button- also can press" Manual" to directly enter manual mode surface)

- Press "Menu" to enter the main menu interface and select the manual mode icon: including message technique, massage part, air pressure, and other message functions.
- Press "Left button" or "Right button" to switch the submenu, then press "Up" or "Down" to select the message function, press "Back" to return to the running status information interface.

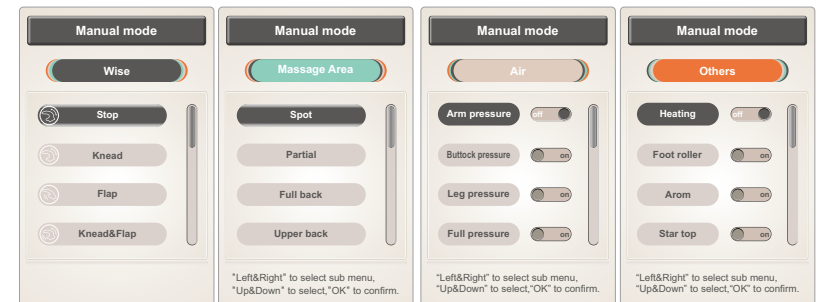
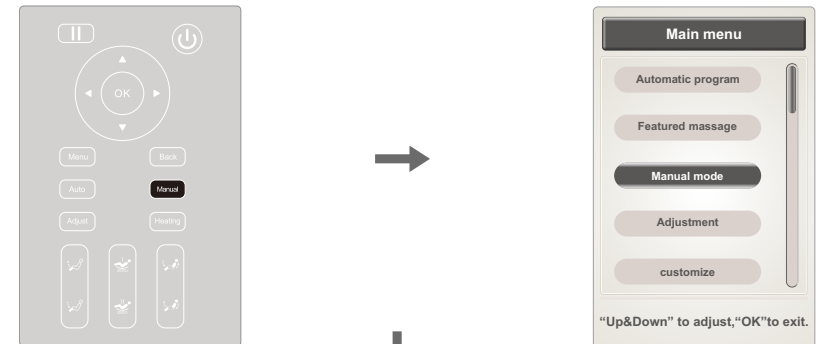

Method of usage

01).Manual Mode (Manual button-mode)

- Manual mode (manipulation): including six different massage techniques such as stopping, kneading, tapping, kneading, finger pressing, 3D, and shoulder lifting. In the state of tapping and finger pressing, the width of the massage ball can be adjusted.
- Press “Up” or “Down” to select the function function icon, press “Enter” to confirm the selected massage method.

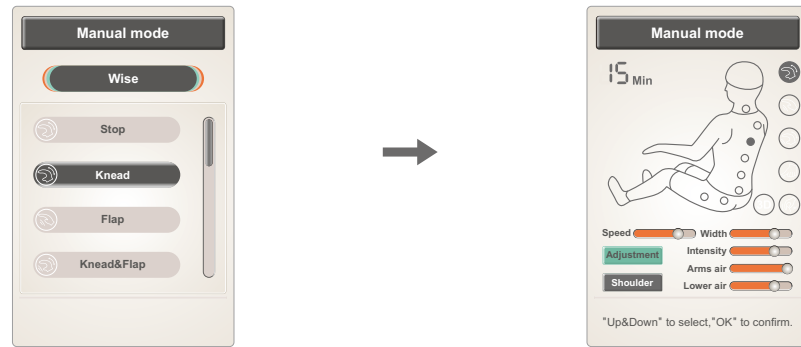

Note:Massage intensity: 3D massage intensity, that is, the robot is extended forward or the whole is retracted. The intensity of the massage is adjusted in the intensity of a certain massage area, not the strength of the full back. Boot detection full body type, the intensity of each massage point has been tested, if you feel the intensity of a certain massage point needs to be adjusted, adjust with this button. The massage intensity can be adjusted at any time in both automatic and manual conditions.

Function	Description	Display
3D massage	Four types of 3D modes are subdivided, and the speed and intensity are adjustable.	3D 3D 3D 3D
Kneading	Speed and strength are adjustable.	🔄
Kneading & Tapping	Speed and strength are adjustable.	🔄
Lifting the shoulder	Speed and strength are adjustable.	🔄
Tapping	Subdivide 2 kinds of tapping modes, speed, width and intensity are adjustable.	🔄 🔄
Shiatsu	Subdivide two kinds of acupressure modes, with adjustable speed, width and strength.	🔄 🔄

Note: Selecting the stop icon stops all tactic functions; selecting the single tactic icon turns on the individual massage technique.

Method of usage

02)Manual mode (manual button - massage area)

- Manual mode (massage area): Massage, fixed, partial, full back, upper back, lower back and other massage functions.
- Press the “Up” or “Down” button to select the area function icon and press the “Enter” button to confirm.

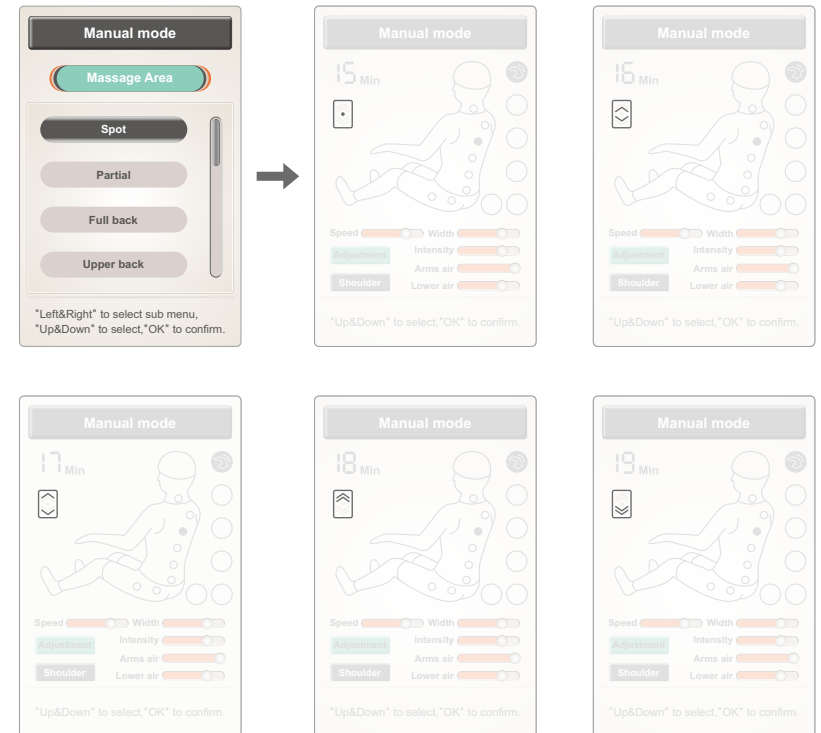

Function	Description	
Spot	Fixed-point massage at a fixed point.	When selecting the fixed point and partial massage techniques, the massage area can be adjusted with the up and down buttons.
Partial	A small range of partial round-trip massage.	
Full back	Massage back and forth on upper back	
Upper back	Massage back and forth on lower back	
Lower back	Massage back and forth on full back	

Method of usage

03).Manual mode (manual button - air pressure)

- Manual mode (air pressure): including arm pressure, buttock pressure, leg pressure, and full air pressure massage.
- Press “Up” or “Down” to select different air pressure massage functions, press “Enter” to confirm.



Function	Description
Arm pressure	Turn the arm pressure massage function on or off.
Buttock pressure	Turn the buttock pressure massage function on or off
Leg pressure	Turn the leg pressure massage function on or off
Full pressure	Turn the full pressure massage function on or off

Method of usage

04).Manual mode (manual button - Others)

- Manual mode (others): including massage, foot roller, aromatherapy, star top and other massage functions.
- Press “Up” or “Down” to select the massage function, press “Enter” to turn the massage function on or off.

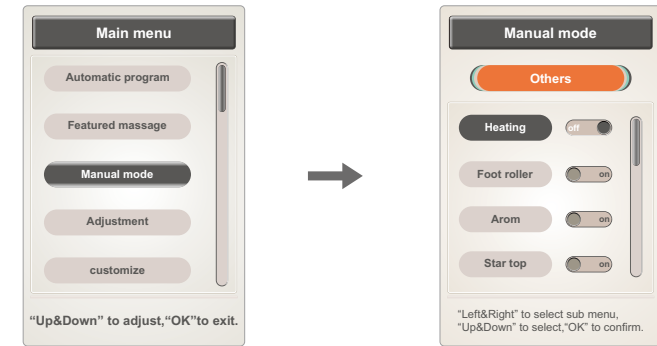

• Manual mode (other - Heating)

- Press the “Confirm” button to turn on or off the back and leg hyperthermia function at the same time, heating to the far-infrared hyperthermia function, and warming after 3 minutes.
- Press “Up” or “Down” to select other massage functions, press “Back” to return to the running status information interface.

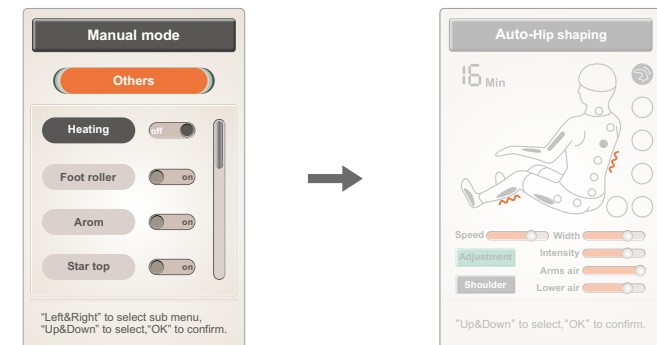

Note: The heating function can also be used to directly turn the heating function on or off by pressing the “heat button”.

Method of usage

• Manual mode (other - sole roller)

- Select to turn the foot roller massage function on or off by pressing the "Enter" button.
- Press "Up" or "Down" to select other massage functions, press "Back" to return to the running status information interface.

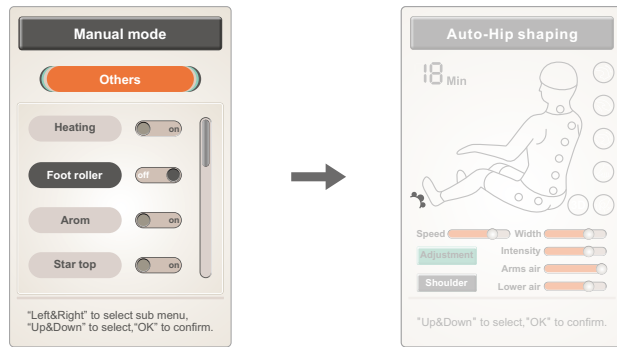

• Manual mode (other - Arom)

- Select to turn the aromatherapy function on or off by pressing the "Enter" button.
- Press "Up" or "Down" to select other massage functions, press "Back" to return to the running status information interface.

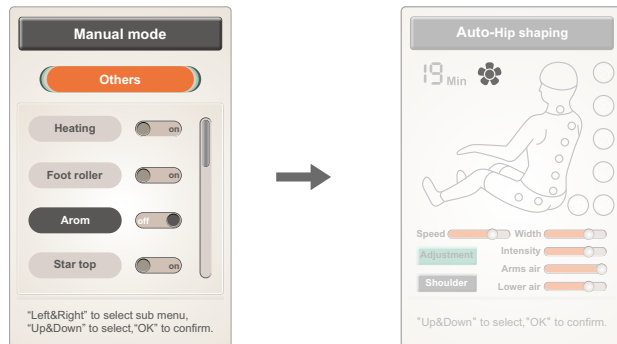

Method of usage

• Manual mode (other - star top)

- Select to turn the star top function on or off by pressing the "Confirm" button.
- Press "Up" or "Down" to select other massage functions, press "Back" to return to the running status information interface.

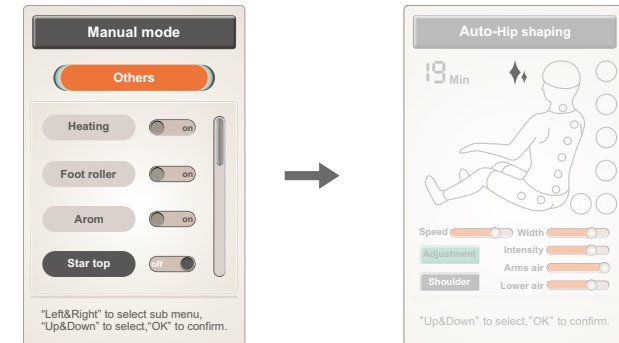

7). Adjustment function (adjustment button - you can also directly press the "adjustment button" to enter the adjustment interface)

- Press "Menu" to enter the main menu interface, select the adjustment function icon: including massage techniques, massage area, intensity, other (currently only timing) and other adjustment functions.
- Press "Left button" or "Right button" to switch the submenu function, select the massage function in the menu, press "Up" or "Down" to select the function to be adjusted, press "Enter" to confirm, or press "Back". Return to the running status information interface.

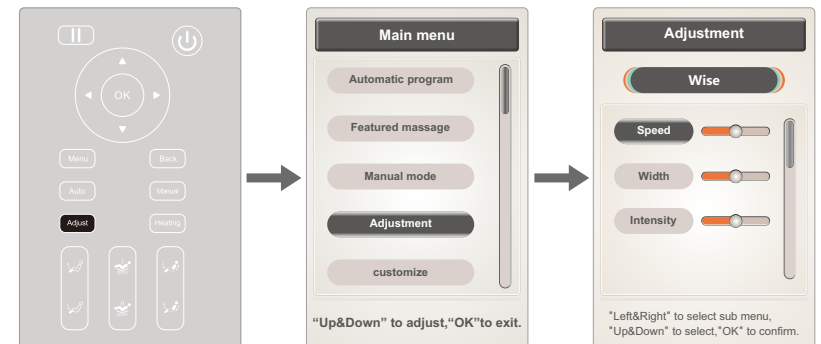

Method of usage

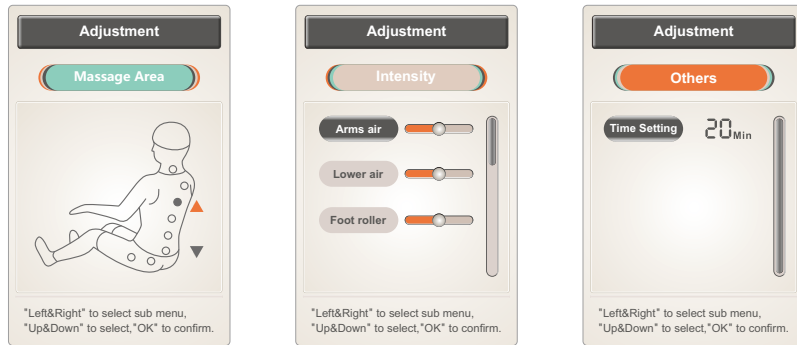

01).Adjustment function (adjustment button - technique)

- Adjustment function (method): The massage technique adjustment function includes speed, width, massage intensity and other massage function adjustments.
- Press the “Up” or “Down” button to select the speed or width function, and press the “Enter” button to adjust the speed, width and intensity.

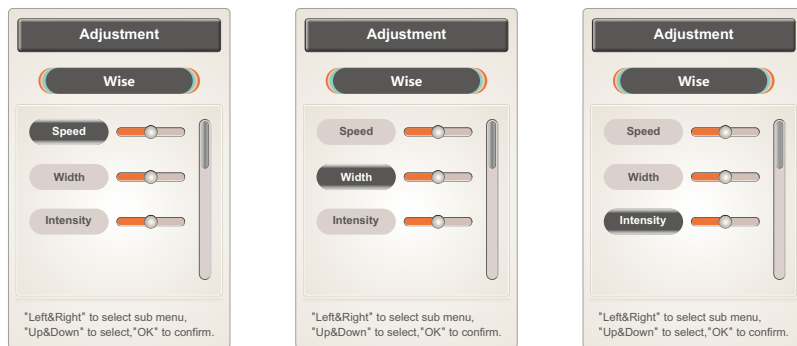

Note:

- Speed: The speed of the massage of the robot is adjusted, a total of 5 files.
- Width: In the stop, tap, and acupressure, the width can be adjusted, a total of 5 files.

Method of usage

02).Adjustment function (adjustment button - massage area)

- Adjustment function (massage area): In the state of fixed point or partial massage area, press and hold the "up button" to release the massage robot and walk up, stop and stop; press and hold the "down button" to release the massage robot down Walk, release and stop.
- Press the “Up” or “Down” button to adjust the massage area.

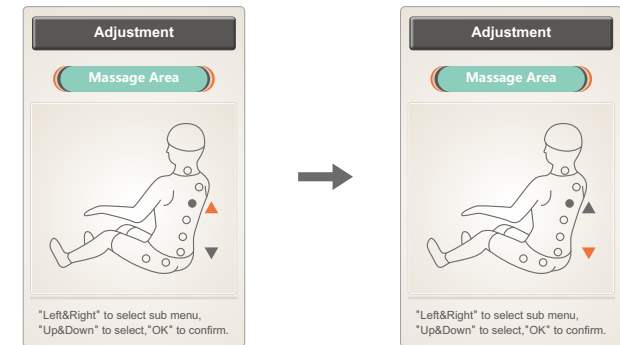

03).Adjustment function (adjustment button - strength)

- Adjustment function (strength adjustment): including arm air pressure, lower body air pressure, and foot roller, a total of 3 speeds can be adjusted.
- Press “Up” or “Down” to select the air pressure or the wheel strength, and press “Enter” to adjust the intensity.

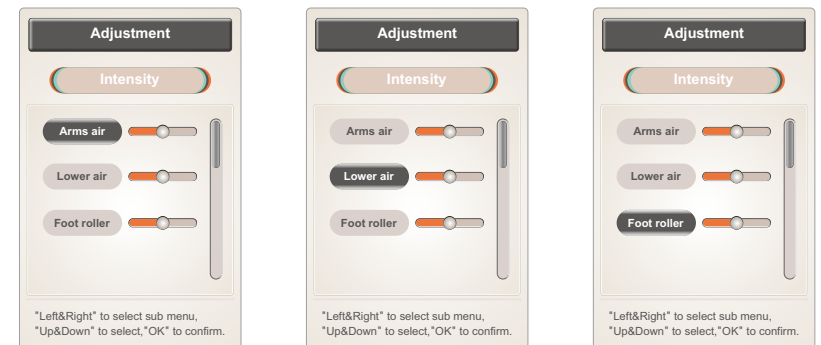

Method of usage

04).Adjustment function (adjustment button - other adjustments)

- Adjustment function (other adjustments), currently only timing. Each time you press the "Confirm" button, it will be superimposed in 5 minutes. If it is more than 40 minutes, it will be subtracted by 40 minutes.
- Press the "Confirm" button to adjust the time (the time for each press of the "Confirm" button is increased by 5 minutes, the minimum is 5Min, the maximum is 40Min, and the cycle is repeated).

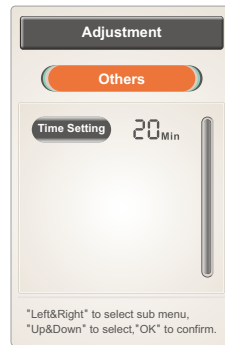

8).Custom

- Press "Menu" to select "Custom" function under the main menu, enter the custom interface and select the custom storage I, II, III storage or calling function.
- Select the archive or application via "Left Button" or "Right Button" and select "Confirm" to confirm.
- Select Custom Storage I, Custom Storage II, and Custom Storage III via Up or Down.
- Storage: Store all current tactics, air pressure, angles, and other massage functions.
- Call: Recall the previously stored techniques, air pressure, angle, and other massage functions.
- Press "Back" to return to the running status information interface.

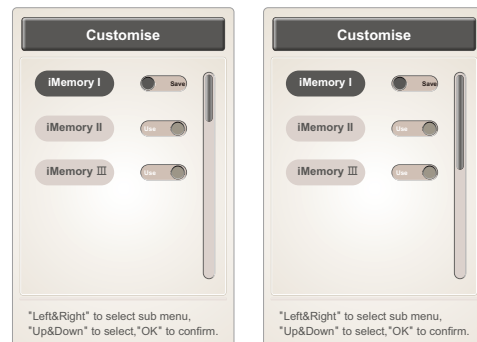

Method of usage

9).Setting

- Press "Menu" to enter the main menu interface, select "Settings" function icon, enter the setting interface including language, backlight, lock screen and other setting interface.
- Press "Left button" or "Right button" to switch the submenu. Press "Up" or "Down" to select the function, or press "Back" to return to the running status information interface.

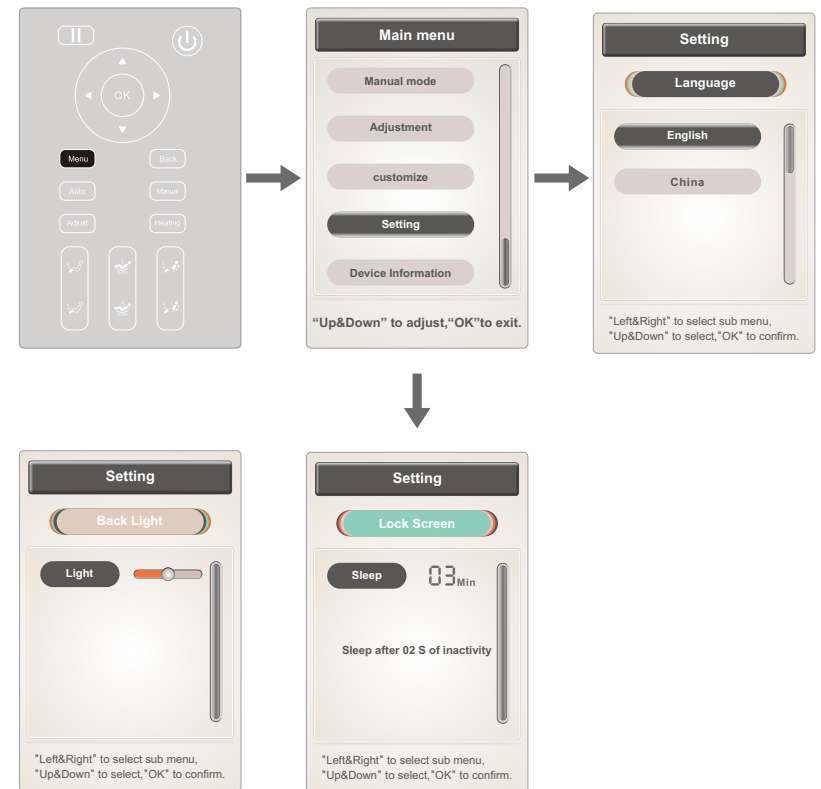

Method of usage

01).Settings (language)

- Settings (Language): Sets both Chinese and English.
- Press “Up” or “Down” to select the language type and press “Enter” to confirm.

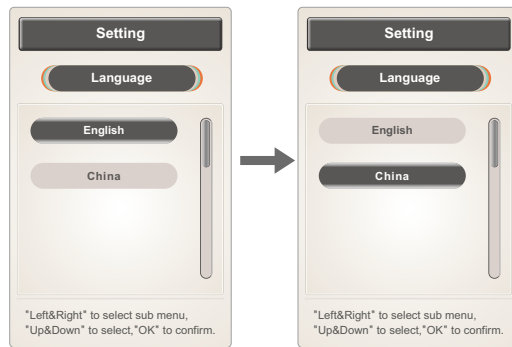

02).Settings (lock screen)

- Settings (lock screen): include time or never lock screen.
- Press the “Confirm” button to adjust the lock screen time. Each time you press the “Confirm” button, the lock screen time is increased by 15 seconds, 30 seconds, 1 minute, 2 minutes, 3 minutes or never lock the screen. Press the “Confirm” button to cycle.

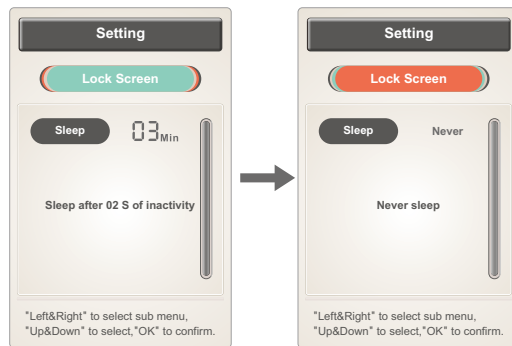

03).Settings (backlight)

- Set (backlight) brightness, press “Enter” to adjust the brightness, a total of 5 brightness can be adjusted.
- Press the Back button to return to the Run Status Information screen.



Method of usage

10). Device information

- Press “Menu” to enter the main menu interface and select the device information function to display the current device information.
- Press “Up” or “Down” to select and press “Enter” to confirm. Or press “Back” to return to the running status information interface.

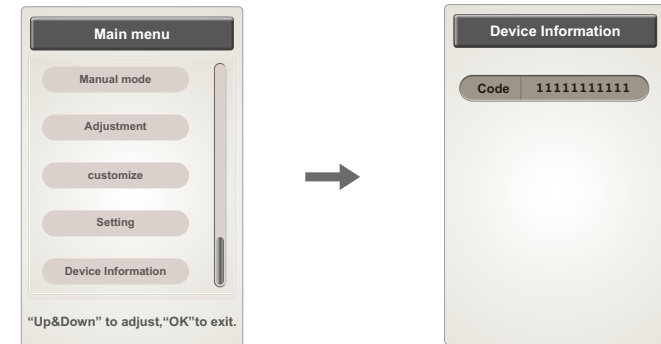

11). Zero gravity button

- Press “Zero Gravity I” or “Zero Gravity II” to automatically adjust the position of the calf and backrest to the zero gravity position. There are two different zero-gravity lying modes, which can be freely selected.

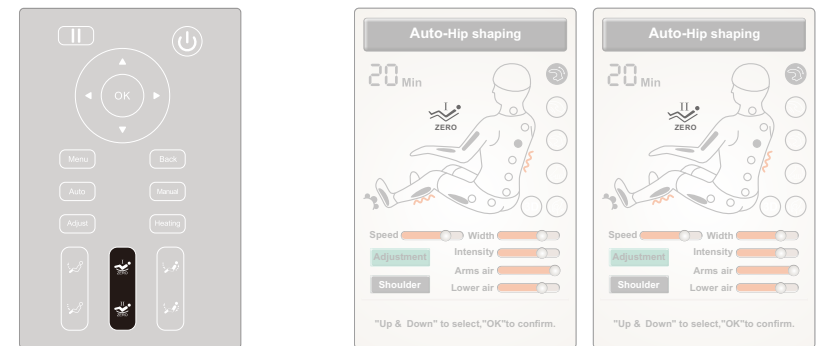

Button	Description
	Zero Gravity I: Automatically adjusts the position of the calf and backrest to the zero gravity I position.
	Zero Gravity II: Automatically adjusts the position of the calf and backrest to the zero gravity II position.

Method of usage

12). Heat button

· Press the “heating button” to turn on or off the back and calf hyperthermia function at the same time; after the thermotherapy function is turned on, the information interface displays the heating icon, and the heating is the far infrared hyperthermia function, which is warm after 3 minutes.

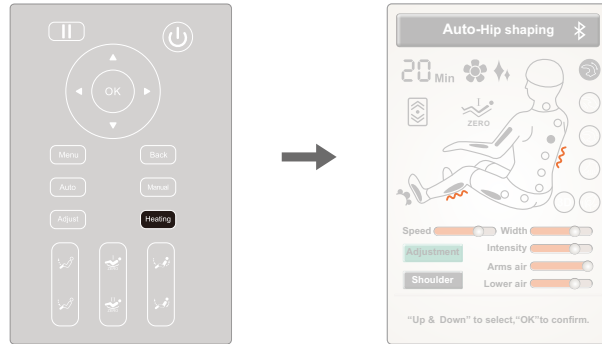

13). Back button

· To adjust the massage function, if you need to return to the main interface, press this button to return to the operation status information interface.

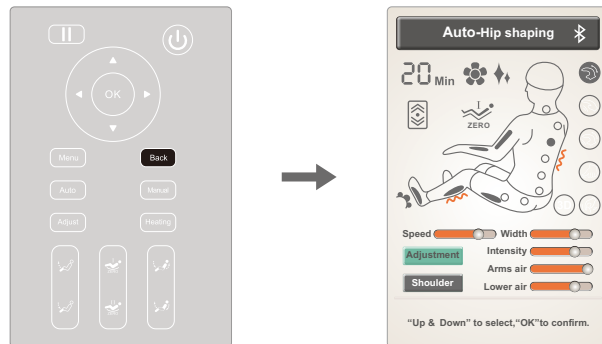

Method of usage







14).Lying angle adjustment button

Button	Description
	Calf up button: Press and hold this button to slowly raise the calf frame, release to stop rising; the calf frame rises after the completion, the calf will automatically detect the length of the foot.
	Calf down button: Press and hold this button to slowly lower the calf frame, release to stop falling; lower leg rest after the completion, the calf will automatically detect the length of the foot.
	Link up button: press and hold this button, the backrest frame rises slowly, while the calf frame slowly descends, and the release stops the backrest frame rises or the lower leg frame descends; after the joint kick-up action is completed, the calf will automatically detect the length of the foot.
	Linking lying button: Press and hold this button to slowly lower the backrest frame, while the calf frame slowly rises and the release stops the backrest frame is lowered or the calf frame is raised; after the joint lying movement is completed, the calf will automatically detect the length of the foot.

15).Handrail shortcuts

Button	Description
	Power button: Press this button to turn the massage function on or off.
	Link up button: Turn this button counterclockwise to slowly raise the backrest frame, while the calf frame slowly descends. Stop the rotation to stop the back frame rise or the lower leg frame to fall; after the joint kicking action is completed, the calf the length of the foot will be automatic ally detected.
	Linking lying button: Turn this button clockwise to slowly lower the backrest frame, while the calf frame rises slowly.Stop the rotation to stop the fall of the back frame or the rise of the lower leg frame; after the joint lying movement is completed, the calf The length of the foot will be automatically detected.
	Heating button: turn on or off the heating and heat treatment function, heating to far infrared heat therapy function, open for 3 minutes After the warmth.
	Aromatherapy button: Turns the aromatherapy function on or off.

Method of usage

	Star Top button: Turns the star blue top physiotherapy function on or off.
	Zero gravity button: Each time the button is pressed, the position of the calf frame and the back frame is automatically adjusted to the zero gravity position. there are two zero-gravity lying modes, which are cyclically switched.
	Calf stretch button: Press and hold this button to manually adjust the footrest to slowly elongate, and release to stop.
	Calf shortening button: Press and hold this button to manually adjust the footrest to slowly shorten, and release to stop.
AUTO	Auto mode button: Each time you press it, the auto massage function switches.
	Air pressure button: Air pressure mode selection.
	USB jack: USB charging port, which can charge smart devices (such as mobile phones).

3. Turn off power, stop massage

- During the massage process, press the power switch button to immediately turn off all massage functions, the back of the chair and the foot pad are reset, the massage time is up, and all massage functions are immediately turned off, and the back and foot pads are not reset.
- Cut off the power supply of the whole machine, the figure (schematic diagram of the whole machine power cut).

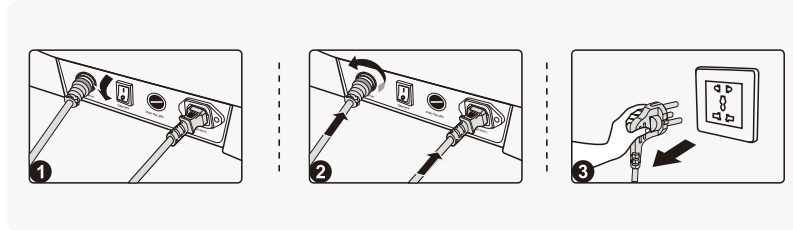

- 1 Schematic diagram of the whole machine power turning off.
- 2 Schematic diagram of unplugging the whole machine wiring.
- 3 Schematic diagram of unplugging the power plug.

Method of usage

4. Fourth, support Apple and Android tablet system, operation control massage chair

Application interface

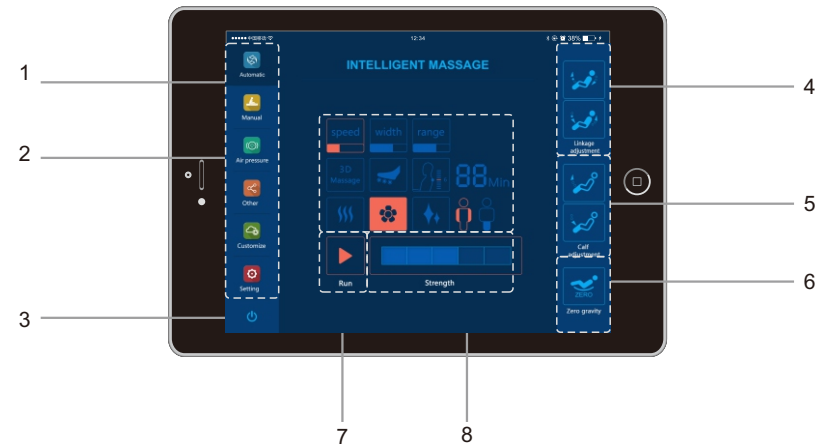

1. Message status information display area
2. Function button
3. switch
4. Linkage adjustment
5. Calf adjustment
6. Zero gravity
7. Intensity adjustment
8. Start/Pause button

1). Preparation before use

01) Installer download and installation

- Download the installer by the installer provided by the installer or by the network download address provided by the dealer.
- Connect the tablet to the computer with a data cable, and install the installer to the tablet via tablet software (such as iTunes for Apple, software for software such as Android). After the installation is successful, the application will be displayed in the app list of the tablet.



Method of usage

2). Bluetooth connection

- Turn on the power switch of the massage chair and automatically turn on the Bluetooth function.
- From the tablet home screen, open the application list and select Settings to open the settings screen.
- Turn on the Bluetooth function → select Bluetooth settings → click to find the accessory device “Bluetooth name: IMCM-XXXX” icon, click the “IMCM-XXXX” icon to pair the tablet Bluetooth module with the massage chair Bluetooth module (the pairing password is “0000”), after successful pairing, click the “IMCM-XXXX” icon to connect the Bluetooth module of the tablet to the Bluetooth module of the massage chair. After the connection is successful, the application can be used to control the massage chair.

3). Bluetooth module abnormality problem and solution

- If the Bluetooth pairing is successful, if you can't connect with the Bluetooth module of the massage chair, please try to cancel the Bluetooth pairing, and then turn off the power of the massage chair and then turn on the power of the massage chair again, then repeat the Bluetooth pairing according to the above Bluetooth connection method.
- The Bluetooth display has been connected successfully, but the massage chair cannot be controlled normally after entering the application, or the message prompt bar displays “Bluetooth not connected”. This status is abnormal for the Bluetooth module. You need to exit the application to reconnect the Bluetooth module, or turn off the massage. After the chair is powered on and then the power of the massage chair is turned back on, the Bluetooth pairing and connection are re-established according to the above Bluetooth connection method.

5.Five, tablet system operation, turn on the whole machine power

- After confirming that the massage chair power switch is off, connect one end of the power cord to the massage chair, and then plug the power cord into a well-grounded power outlet. Then switch the massage chair power switch to the on state.

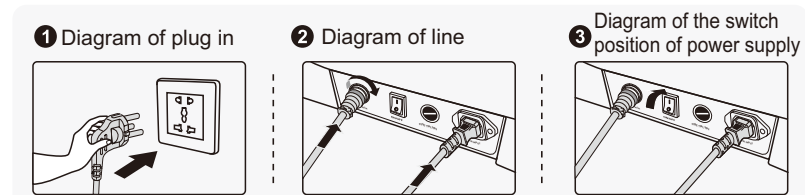

Method of usage

6.Sixth, tablet computer message function control operation

1).Start the message

- From the tablet home screen, open the application list and click the app “iRest” icon to launch the massage chair control app.
- After launching the application, enter the startup interface, click “” to start the message, while the backrest keeps the default position and the calf is slightly raised.
- Enter the waiting to select the automatic mode, select an automatic mode and start the detection. If the automatic mode is not selected within 5 minutes, the massage chair will automatically shut down. Note: Shujing Active only detects the height of the shoulder position, and other automatic modes detect the full body shape and shoulder height.

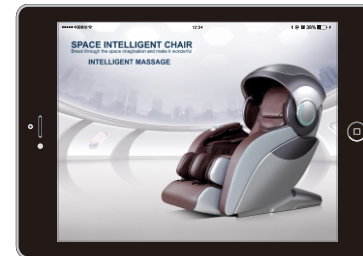

Boot interface

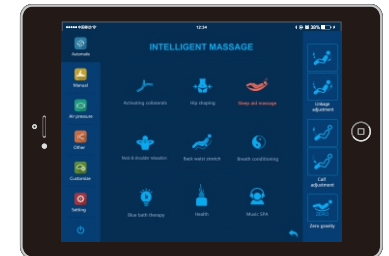

Please select automatic mode

- When you select any of the automatic modes, the backrest and calf position will be adjusted to the set angle.
- After adjusting the angle, the massage chair automatically performs the shoulder position and body type detection (Note: Shujing Active only detects the shoulder position, other modes are full body type detection and shoulder position detection), waiting for the test to be completed. If you press the “” button, skip the shoulder position and body shape detection steps and directly turn on the default value to start the massage.

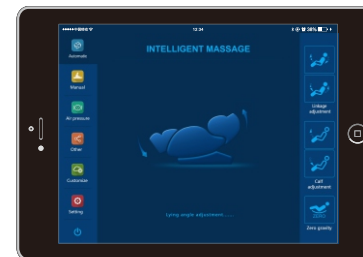

Lying angle adjustment display interface

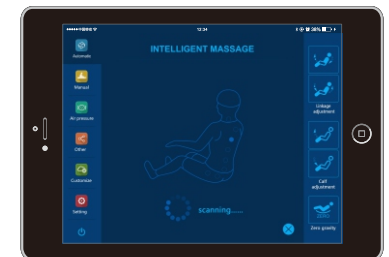

Shoulder position and massage finger pressure detection interface

Method of usage

01). Shoulder position adjustment

- Automatically perform human shoulder position and massage finger pressure point detection, waiting for the test to be completed.
- After the test is completed, enter the shoulder message position adjustment interface and make a “DiDi...” prompt tone. If it differs from the actual shoulder position, you can adjust it to the appropriate position by pressing the “Up” or “Down” button. The shoulder position is adjustable in 11 steps. With no shoulder position adjustment within 10 seconds, the message function is automatically entered. If the shoulder position is not detected, the default shoulder position height is massaged.

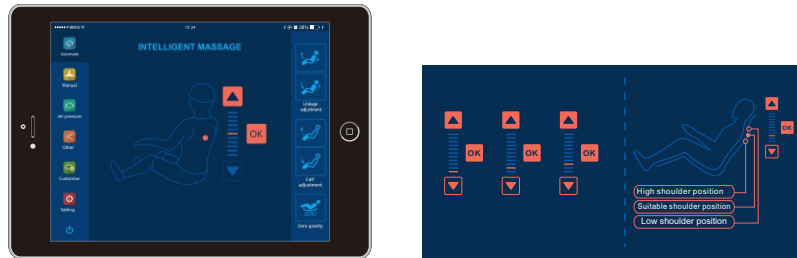

Shoulder position adjustment button	Function description
	Adjustment of shoulder massage position
	Adjustment under the shoulder massage position

02). Message function runs and pauses

- Under the message information display interface under message work, click the “Run/Pause button” to temporarily stop all message functions and enter the message function pause state; while the message function is paused, press the “Run/Pause button” to continue. Run the message function before the pause. If the pause time exceeds 20 minutes, all message functions are automatically turned off.



Method of usage

Button	Function description
	In the running state, press this button to pause all current message functions.
	In the pause state, press this button to continue the message function before the pause.

03). Upper body massage intensity

- Under the message information display interface under message work, click the intensity adjustment icon to adjust the upper body back. The massage intensity of the robot is divided into 5 steps.

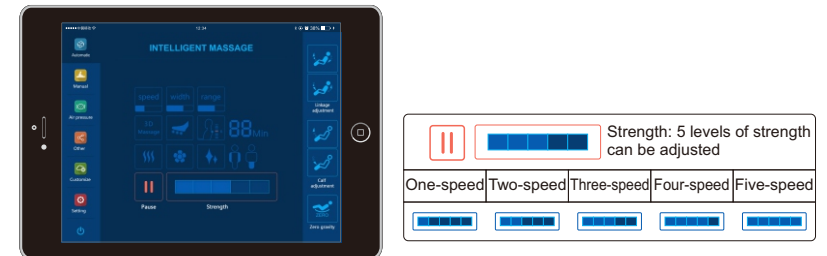

04). Automatic message

- Click the “” button icon to enter the automatic function selection interface, and click the automatic function icon to select the automatic massage mode. Speed and width are not adjustable during automatic massage.



Method of usage

Function	Description
Activating collaterals	Activating collaterals massage function is mainly used to massage the neck, shoulder, back, waist, buttocks, etc. by means of massage, finger pressure, squatting and tapping; and combined with the foot roller and the leg airbag squeeze type, The body is fully massaged. Effectively promote the body's meridians, eliminate fatigue, promote blood circulation, improve the body's immunity, relieve muscle fatigue and soreness. Relax, relieve stress and improve sleep quality. At the same time, it is accompanied by a voice broadcast to explain the function of Shu Jing active massage.
Hip shaping	Taking the buttocks as the massage focus, the hips are shaken and shaken, and the airbags are squeezed together. The hips are swayed and squeezed to effectively relieve the muscles of the buttocks, relieve the sedentary muscles of the buttocks, regulate blood circulation, tighten the buttocks. . Swinging jitter consumes excess fat and elasticity, making the buttocks muscles strong and body-building, with a beautiful arc to reach the perfect female curve beauty.
Sleep aid massage	With a light and gentle method, deep massage on the human body can effectively improve sleep and improve sleep quality, conditioning the body balance, relaxing body and mind, soothe sleep.
Neck & shoulder relaxation	Focus on the neck and shoulders, lift the neck, knead, shoulder beat, smash and other methods on the neck and shoulders massage. It has open and occluded neck and shoulder, activating blood circulation and relieving pain, and relieving neck and shoulder pain.
Back waist stretch	With the back of the back as the massage focus, the back of the back with a shiatsu massage, tamper, back traction and other massage hands the method effectively clears the back and waist meridians, promotes the circulation of the back and back, and relieves the fatigue and soreness of the lumbar muscles.
Breath conditioning	The breath conditioning massage function is mainly combined with kneading, massage, tampering, tapping, lifting and waist balloon extrusion. The neck, shoulders, back and waist massage of the human body, in which the neck and shoulders are mainly kneaded, lifted, smashed and other massage techniques, can alleviate the long-term head or overwork and lead to stiff muscles, soreness and elimination of the neck and shoulders. fatigue. The back waist is mainly based on finger pressure, squeaking and massage. It can dredge the back and meridians, promote blood circulation in the waist and improve back pain. At the same time, relieve anxiety, calm emotions, regulate the breath, and quickly sleep as a dream.

Method of usage

Blue bath therapy	After the blue bath massage function is turned on, the massage chair automatically lies, so that the human body maintains zero gravity, and then cooperates with the blue bathing function on the top of the starry sky. The blue can slow down the heart rhythm, adjust the balance, and eliminate the tension, with the starry sky LED The light and dark adjustment, the user with the light conditioning breathing combined with gentle kneading massage techniques to relieve the body and mind, release stress, relieve fatigue.
Health	After opening the fragrant health massage function, the massage chair is automatically lying down, so that the body is in a state of balance and relaxation, and then combined with massage and air pressure to massage the body in all directions, combined with the unique aromatherapy, the aroma can make people Balance emotions, relax, help sleep, relax muscles, balance body and mind.
SPA Music spa	After the music SPA massage function is turned on, the user can connect music through Bluetooth, and combine the kneading, tapping massage technique and airbag squeeze massage function to enjoy a relaxing massage with music. Appreciating music effectively for a long time can relieve bad mental reactions, calm down moods, cultivate temperament, change character and taste.

2).Manual massage

- Click the “” button icon to enter the manual massage function selection interface, select manual massage technique, back massage, speed and width function.

01) .Manual massage - technique, speed, width

- In the manual function selection interface, click the “” icon to enter the manual massage function selection interface, including six different massage techniques such as kneading, tapping, kneading, finger pressing, 3D, and shoulder lifting. In the state of tapping and finger pressing, the width of the massage ball can be adjusted.

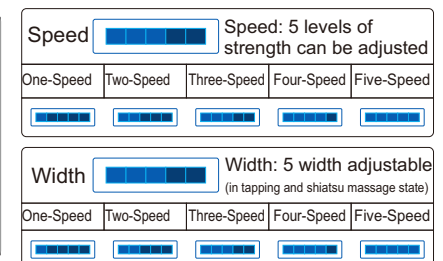
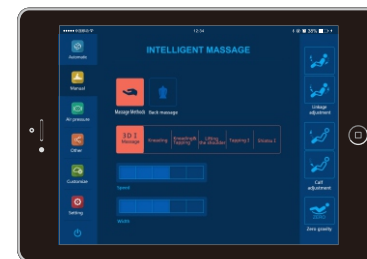

Method of usage

Note: Massage intensity: 3D massage intensity, that is, the robot is extended forward or the whole is retracted. The intensity of the massage is adjusted in the intensity of a certain massage area, not the strength of the full back. Boot detection full body type, the intensity of each massage point has been tested, if you feel the intensity of a certain massage point needs to be adjusted, adjust with this button. The massage intensity can be adjusted at any time in both automatic and manual conditions.

Function	Description
3D massage	Four types of 3D modes are subdivided, and the speed and intensity are adjustable.
Kneading	Speed and strength are adjustable.
Kneading & Tapping	Speed and strength are adjustable.
Lifting the shoulder	Speed and strength are adjustable.
Tapping	Subdivide 2 kinds of tapping modes, speed, width and intensity are adjustable.
Shiatsu	Subdivide two kinds of acupressure modes, with adjustable speed, width and strength.

02).Manual massage - back stretching

· In the manual function selection interface, click the “” icon to enter the massage stretch mode selection interface, and click the pair stretch mode icon to select the personalized massage function.

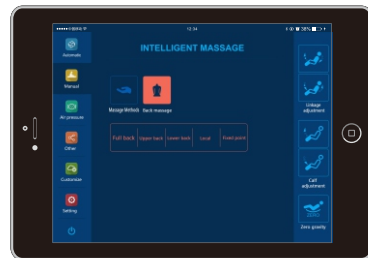

 **Note:**
In the state of lifting the massage technique on the shoulder, the extension mode selection is invalid.

Function	Description
Full back	Full back up and down massage.
Upper back	The upper part of the back is massaged up and down
Lower back	The lower part of the back is massaged up and down.
Local	A small amount of back and forth massage on the back.
Fixed point	A fixed position massage on the back.

Method of usage



3).Air pressure massage

· Click the “” button icon to enter the air pressure massage function selection interface, and click the corresponding air pressure function icon to select the air pressure massage function. Pneumatic massage functions include foot power, arm pressure, full air pressure, hip pressure, and leg pressure.

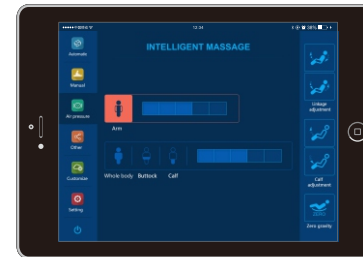
01). Air pressure massage - arm



Intensity  Intensity: 3 levels of intensity can be adjusted

One-Speed	Two-Speed	Three-Speed
		



Adjust the arm air pressure intensity with a total of 3 strokes when the arm air pressure is on.

Function	Description
	Press this button to turn the arm pressure massage function on or off

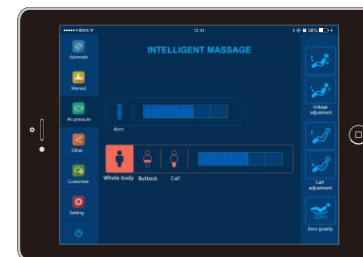
02).Air pressure massage - full air pressure, buttock pressure, leg pressure



Intensity  Intensity: 3 levels of intensity can be adjusted

One-Speed	Two-Speed	Three-Speed
		

At full air pressure, hip pressure, and leg air pressure, the air pressure massage intensity can be adjusted for a total of three strengths.

Function	Description
Full pressure	Press this button to turn the body pressure massage function on or off.
Hip	Press this button to turn the hip pressure massage function on or off.
Leg	Press this button to turn the leg pressure massage function on or off.

Method of usage

4). Other functional massage

01).Other functional massage - hyperthermia function

- Click the “

Button	Description
	Press this button to turn on or off the back and calf hyperthermia function, and heat it to far infrared heat therapy function.It is warm after 3 minutes of opening.

02).Other functions massage - aromatherapy function

- Click the “

Button	Description
	Press this button to turn the aroma function on or off.

Method of usage





03).Other functions massage - star top function

- Click the “

	Press this button to turn the star top function on or off.
---	--

04).Other functional massage - sole roller

- Click the “

Speed		Speed: 3 levels of intensity can be adjusted			
One-Speed		Two-Speed		Three-Speed	

Button	Description
	Press this button to turn the foot roller massage function on or off

Method of usage



05).Other functions massage - smart archive function

- Click the “



6).Settings - Language Settings:

- Click the “

7). Position adjustment of the backrest frame and the small leg

Button	Description
	Calf up button: Press and hold this button to slowly raise the calf frame, release to stop rising; the calf frame rises when finished, the calf will automatically detect the length of the foot.
	Lower leg lowering button: Press and hold this button to slowly lower the calf frame, release to stop falling; lower leg lowering action when finished, the calf will automatically detect the length of the foot.

Method of usage

	Linking up button: Press and hold this button, the backrest frame will rise slowly, while the calf frame will slowly descend. When released, the backrest frame will be raised or the lower legrest will be lowered. After the joint kicking action is completed, the calf will automatically detect the length of the foot.
	Linking lying button: Press and hold this button to slowly lower the backrest frame, while the calf frame slowly rises and the release stops. The backrest frame is lowered or the calf frame is raised; after the joint lying movement is completed, the calf will automatically detect the foot minister degree.
	Zero gravity button: Each time the button is pressed, the position of the calf frame and the backrest frame is automatically adjusted to zero gravity position. Zero gravity lying mode, cycle switching

8).Wireless Bluetooth music playback operation

- With Bluetooth-enabled audio source devices (such as mobile phones, MID tablets, etc.) paired with the Bluetooth module of the massage chair, the music played by the audio source device can be wirelessly transmitted to the massage chair audio system for music playback via Bluetooth wireless.

7.Seven, tablet system operation, turn off the power, end the massage

- When the massage function is on, click the massage button on the massage information display interface to immediately turn off all massage functions.
- Cut off the power supply of the whole machine, the figure (schematic diagram of the whole machine power cut).

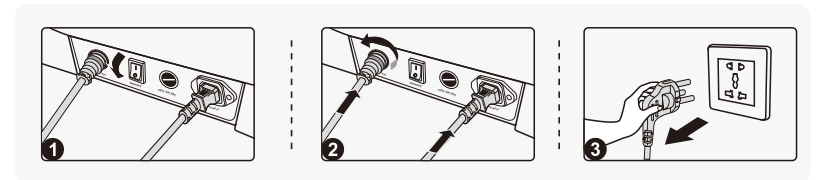

- 1 Schematic diagram of the whole machine power turning off.
- 2 Schematic diagram of unplugging the whole machine wiring.
- 3 Schematic diagram of unplugging the power plug.

 Note:	Switch the massage chair power switch to the off state, and then unplug the power cord from the power outlet.
---	---

Method of usage

8.Eight, handrail installation instructions

- Find the connecting plug corresponding to the armrest from the bottom of the frame and pierce it from the middle of the armrest steel frame (Figure 1).
- After inserting the connecting plug from the middle of the armrest steel frame, corresponding to each pair of wiring plugs (Figure 2).

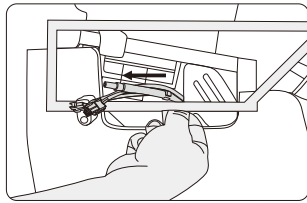

Figure 1

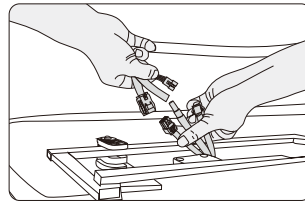

Figure 2

- The connector from the bottom of the frame is connected to the armrest connector firmly, and the air pipe connector is also inserted into place (Fig. 3).
- After the connector is connected, gently push the top of the frame into the bottom of the frame with the hand fixed on the steel frame, taking care to avoid the pipe collapse (Figure 4).

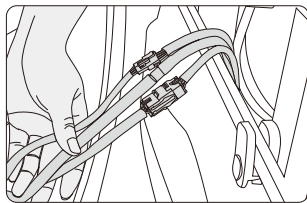

Figure 3

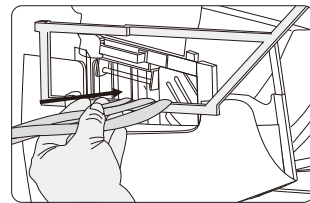

Figure 4

- As shown in the figure, the three hooks on the handrail are to be hooked to the steel pipe of the handrail steel frame (Fig. 5).
- Hold the front and rear ends of the armrests with both hands. Before the armrests are low and high, first hook the front end of the armrests to the front end of the armrest steel frame. (Check if the connecting cable is inserted into the lower part of the armrest frame to avoid jamming.) Then hook the hooks under the armrests to the steel. The frame presses the rear end of the armrest down and presses the upper two hooks into the steel frame (Fig. 6).

Method of usage

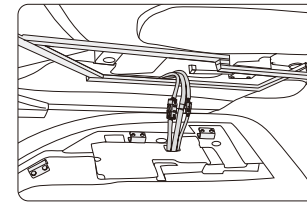

Figure 5

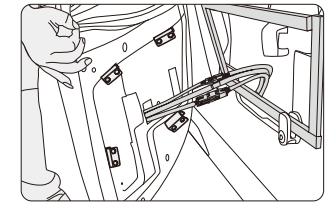

Figure 6

- After the armrest is placed on the fixed steel frame, press the hands together from the front and rear of the handrail so that the three hooks of the handrail are fixed on the steel frame, and gently shake the handrail to check whether it is hooked (Fig. 7).
- Locate the mounting hole on the front of the fixed steel frame as shown in the figure. Screw the hexagon socket screw into the screw with the Allen button (Figure 8).
- Locate the mounting hole on the rear of the fixed steel frame as shown in the figure. Screw the hexagon socket screw into the inner arm of the fixed hexagonal wrench and fix it. The installation steps are the same (Figure 9).

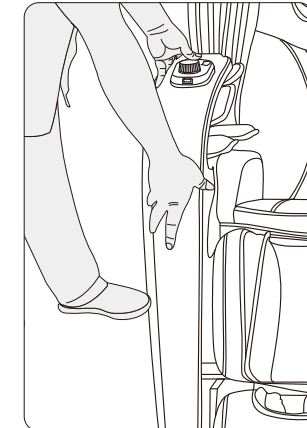

Figure 7

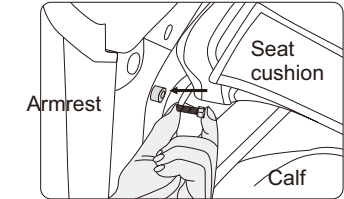

Figure 8

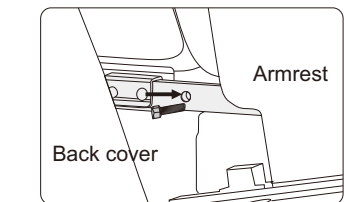
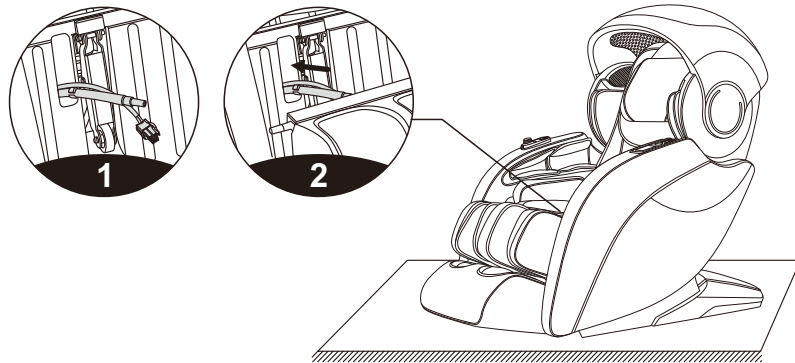

Figure 9

Method of usage

9.Nine, calf installation instructions

1. Cut the connecting wire and the air pipe tie fixed on the front sealing plate first.
2. Connect the connecting wire and the air pipe and the leg joint in the hole of the front sealing plate, and confirm whether the docking is in place, and then insert the docking cable and the air pipe inward from the front sealing plate hole, and insert it under the frame, and pay attention to Avoid obstruction of the trachea when inserted.



3. Insert the rotating inner sleeve and the rotating outer sleeve into the left side of the calf and the right side of the lower leg (note: the large step must face inward).
4. Open the calf support hinge cover on the left and right mounts of the massage chair.

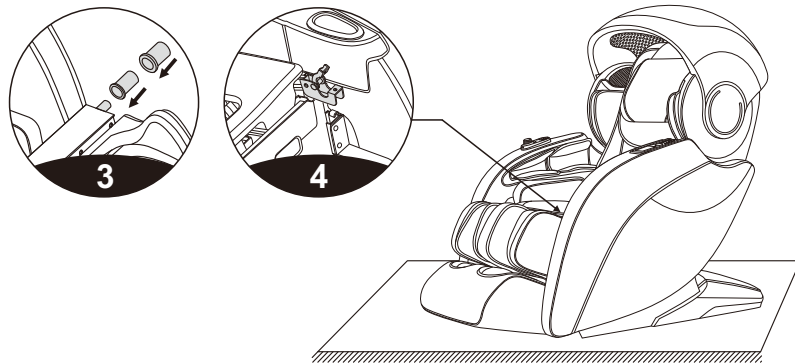

Method of usage

5. Then hang the lower leg (left and right shaft) into the frame support hinge plate (Figure 5).
6. Cover the rotating shaft cover, press the calf to rotate the outer sleeve, and then use the 4# hex wrench provided to tighten 2 M5×14-12.9 black zinc environmental protection hexagon socket head cap screws and a 6×12× 1.5 Black zinc environmental protection flat pad locks the calf support rotating cover and the calf is installed (Fig. 6).

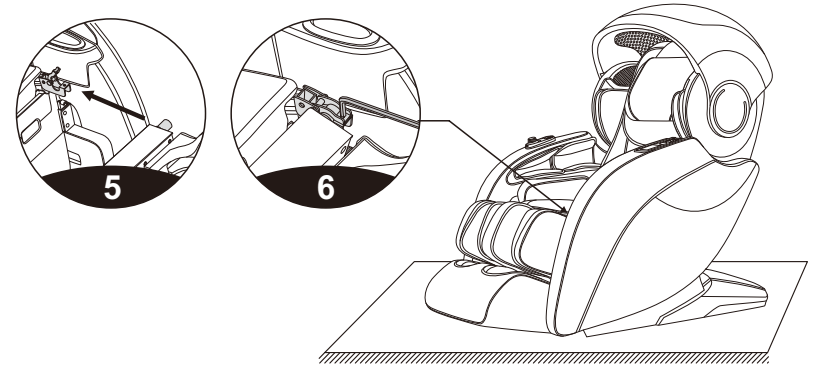

7. After the screw is locked, the rear slot of the calf cover is snapped into the pin shaft, and then the front end of the lower leg cover is pressed down and the rotating shaft cover is pressed. completely parallel and parallel, then use the M4 screw to lock the calf rotating shaft cover and the calf is installed.

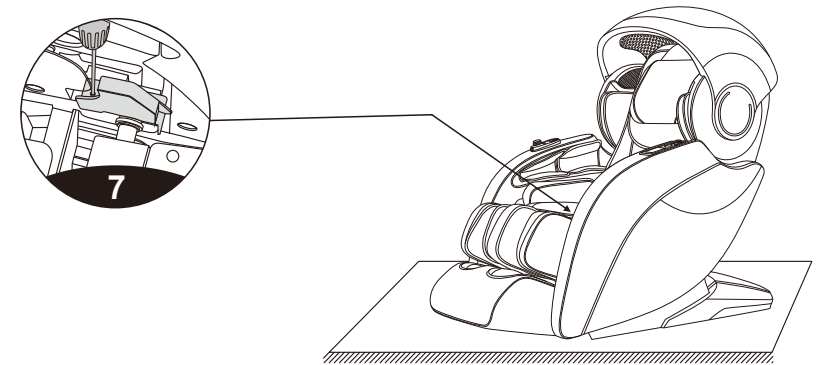

Method of usage

10. Ten, aromatherapy installation instructions

- Rotate the capsule cover to the back of the massage chair. You can see the aromatherapy device on the right side of the massage chair (Figure 1).
- Rotate the aromatherapy holder knob to the unlock position and remove the empty aroma stick (Figure 2).

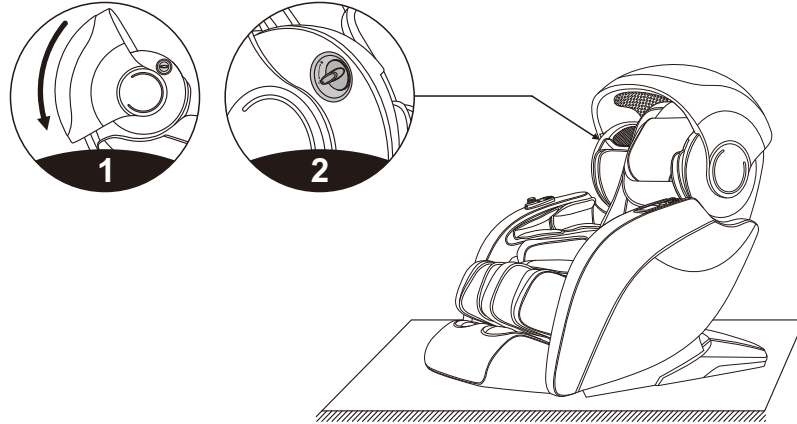

- After removing the empty aroma stick, attach the new aroma stick to the aroma holder. Then align the arrow on the aroma holder with the unlocked position on the upper arm trim and load the aroma stick (see Figure 3).
- Rotate the aromatherapy holder to the position of the lock closure mark, you can lock it, and the aroma stick is installed (Figure 4)

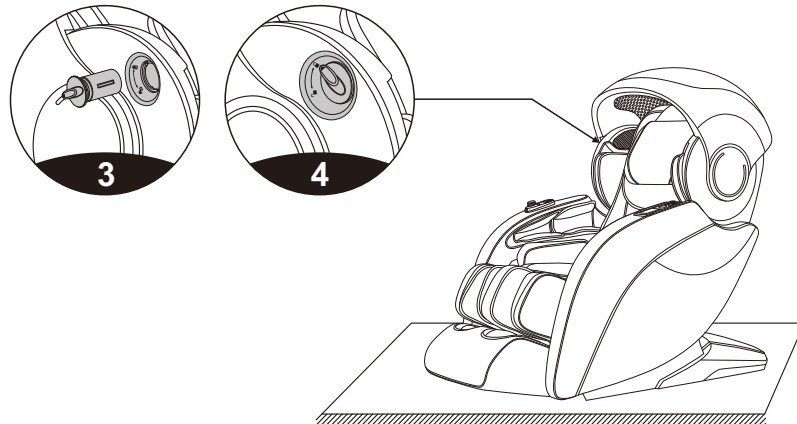

Method of usage

11. Head cushion and backrest pad's dismounting and use manual

- Using head cushions can reduce the kneading massage intensity on neck and shoulder, according to your needs to decide whether the head cushions is needed (recommend head cushions). Backrest cushion and backrest connected by zipper (1), head cushions and backrest pad connected by thread gluing (2).

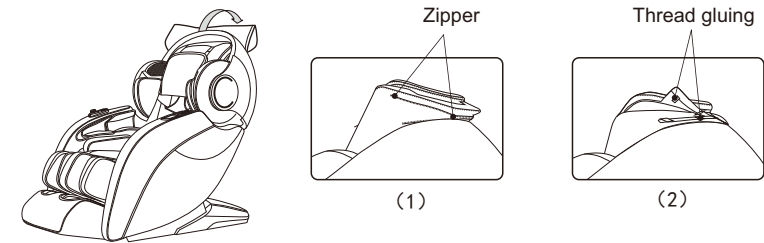

12. Floor protection

- Put the heavy massage chairs on the wood floor for a may damage the floor, so please place a carpet or other object to avoid this damage.

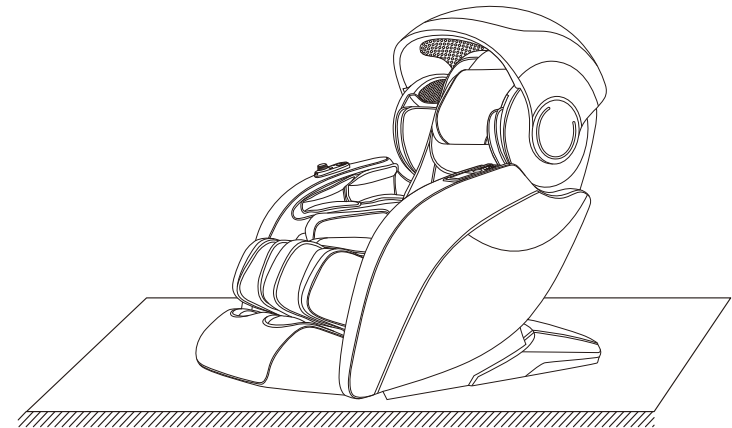

Caution: Do not move the chairs with its wheels on wood floor, rough ground or in a narrow space. Two people are required to lift the chair. During the lifting period, take the calf rest end sealing plate and backrest cover grooves as the force-bearing point(Please do not lift armrest directly.)

Method of usage

13.Method of movement

·When moving, first make sure all the wires are pulled out of the massage chair. On the left and right sides of the massage chair, hold the lower edge of the armrest with both hands, and then lift the massage chair upwards with force. Lift the massage chair to the appropriate position and gently lower the massage chair. Pay attention to the position of the foot when putting down the massage chair to avoid being pressed against the foot by the massage chair

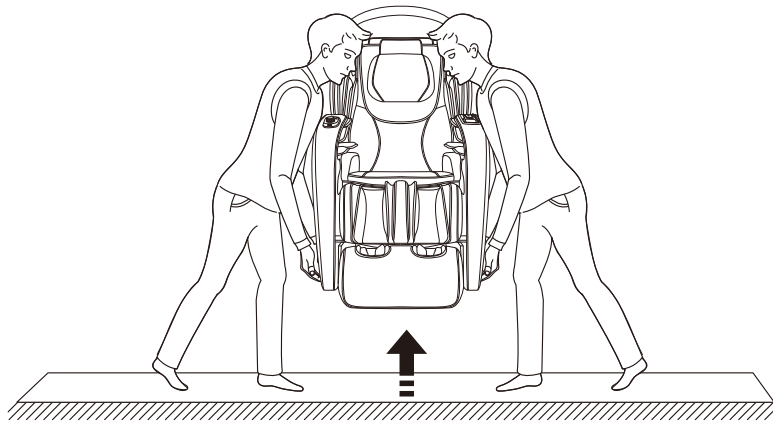

Note: Be sure to turn off the power switch and unplug the power cord and the hand controller cable while moving.

Product specification

Model: SL-A802

Name: Massage Chair

Rated voltage: 110-120V~ 60Hz
220-240V~ 50Hz/60Hz

Rated power input:260W

Rated time: 20Min

Safety structure: Class I

Material introduction: PVC, PA, steel parts and electric & electron parts

MATERIAL	PU	LEATHER	CLOTH	WOOD